



# UltraView IP XP4 Box Day/Night Range Camera User Manual

<b>Copyright</b>	© 2012 UTC Fire & Security Americas Corporation, Inc. Interlogix is part of UTC Climate Controls & Security, a unit of United Technologies Corporation. All rights reserved.
<b>Trademarks and patents</b>	The UltraView name and logo are trademarks of United Technologies.  Other trade names used in this document may be trademarks or registered trademarks of the manufacturers or vendors of the respective products.
<b>Manufacturer</b>	UTC Fire & Security Americas Corporation, Inc. 2955 Red Hill Avenue, Costa Mesa, CA 92626-5923, USA  Authorized EU manufacturing representative: UTC Fire & Security B.V. Kelvinstraat 7, 6003 DH Weert, The Netherlands.
<b>Certification</b>	  N4131
<b>FCC compliance</b>	Class A: This equipment has been tested and found to comply with the limits for a Class A digital device, pursuant to part 15 of the FCC Rules. These limits are designed to provide reasonable protection against harmful interference when the equipment is operated in a commercial environment. This equipment generates, uses, and can radiate radio frequency energy and, if not installed and used in accordance with the instruction manual, may cause harmful interference to radio communications. Operation of this equipment in a residential area is likely to cause harmful interference in which case the user will be required to correct the interference at his own expense.
<b>ACMA compliance</b>	Notice! This is a Class A product. In a domestic environment this product may cause radio interference in which case the user may be required to take adequate measures.
<b>Canada</b>	This Class A digital apparatus complies with Canadian ICES-003. Cet appareil numérique de la class A conforme à la norme NMB-003 du Canada.
<b>European Union directives</b>	2004/108/EC (EMC directive): Hereby, UTC Fire & Security Americas Corporation, Inc., declares that this device is in compliance with the essential requirements and other relevant provisions of Directive 2004/108/EC.
	2002/96/EC (WEEE directive): Products marked with this symbol cannot be disposed of as unsorted municipal waste in the European Union. For proper recycling, return this product to your local supplier upon the purchase of equivalent new equipment, or dispose of it at designated collection points. For more information see: <a href="http://www.recyclethis.info">www.recyclethis.info</a> .
<b>Contact information</b>	For contact information see our Web site: <a href="http://www.interlogix.com">www.interlogix.com</a> or <a href="http://www.utcssecurityproducts.eu">www.utcssecurityproducts.eu</a>

# Content

## **Introduction 2**

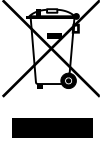
Product description 2

Features 2

## **Installation 3**

Installation environment 3

Package contents 3

Cable requirements 3

Setting up the camera 4

Camera description 5

Lenses 5

Mounting the camera 5

Connections 6

Alarm connection 6

Connecting analog cables 7

Setting the camera DIP switches 7

Description of the DIP switch settings 8

## **System configuration 9**

Software requirements 9

Windows Vista and 7 users 9

Accessing the camera over the internet 10

Overview of monitoring and configuring the system 10

Live viewing 11

Monitoring the system 11

Configuring the camera and network 13

# Introduction

## Product description

The UltraView IP XP4 box day/night range camera uses a digital signal processor (DSP) to process video signals. The video camera includes a microcontroller to provide high-quality images with high-color reproduction and sharp pictures.

### Product codes:

- UVC-IP-XP4DN-HR
- UVC-IP-XP4DN-HR-P

## Features

Camera features include:

- H.264-SVC video compression with multistream capability
- Pixim Seawolf technology
- Excellent performance in almost any lighting conditions
- Supports up to 4CIF resolution (540HTVL analog)
- True day/night (removable IR cut filter)
- Long life and high reliability
- DIP switch control of camera settings
- Power over Ethernet (PoE) or Isolated switching power 12 VDC or 24 VAC

# Installation

## Installation environment

When installing your product, consider these factors:

- **Electrical:** Install electrical wiring carefully. It should be done by qualified service personnel. Always use a proper PoE switch or a 12 VDC or 24 VAC UL listed Class 2 or CE certified power supply to power the camera. Do not overload the power cord or adapter.
- **Ventilation:** Ensure that the location planned for the installation of the camera is well ventilated.
- **Temperature:** Do not operate the camera beyond the specified temperature, humidity or power source ratings. The operating temperature of the camera is between -30 to +50°C (-22 to +122°F). Humidity is below 90%.
- **Moisture:** Do not expose the camera to rain or moisture, or try to operate it in wet areas. Turn the power off immediately if the camera is wet and ask a qualified service person for servicing. Moisture can damage the camera and also create the danger of electric shock.
- **Servicing:** Do not attempt to service this camera yourself. Any attempt to dismantle or remove the covers from this product will invalidate the warranty and may also result in serious injury. Refer all servicing to qualified service personnel.

---

**WARNING:** To reduce the risk of fire or electronic shock, do not expose the camera to rain or moisture and do not remove the cover or back.

---

## Package contents

The camera is shipped with the following items:

- The camera assembly
- 1 channel passive video transceiver
- AC power wiring harness
- 150 mm DC jack to terminal adapter

## Cable requirements

For proper operation, adhere to the following cable and power requirements for the cameras. Category 5 cabling or better is recommended. All network cabling must be installed according to applicable codes and regulations.

Table 1 below lists the requirements for the cables that connect to the camera.

**Table 1: Recommended cable requirements**

Cable type	Requirements
Video	75 ohm RS-59 coaxial cable with BNC ends
Power	24 VAC cable

## Setting up the camera

**Note:** If the light source where the camera is installed experiences rapid, wide-variations in lighting, the camera may not operate as intended.

### To quickly put the camera into operation:

1. Connect the lens to the camera.
2. Prepare the mounting surface and mount the camera to the wall/ceiling using the appropriate fasteners.
3. Connect the cables to the camera.
4. Connect a CCTV monitor to the system to program the camera.
5. Set the camera's DIP switches, which are located on the rear of the camera, to suit the camera's location. See "Setting the camera DIP switches" on page 7.
6. Set up the camera's network and streaming parameters so that the camera can be controlled over the network. See "Accessing the camera over the internet" on page 10.

# Camera description

Figure 1: Side view of XP4 box camera

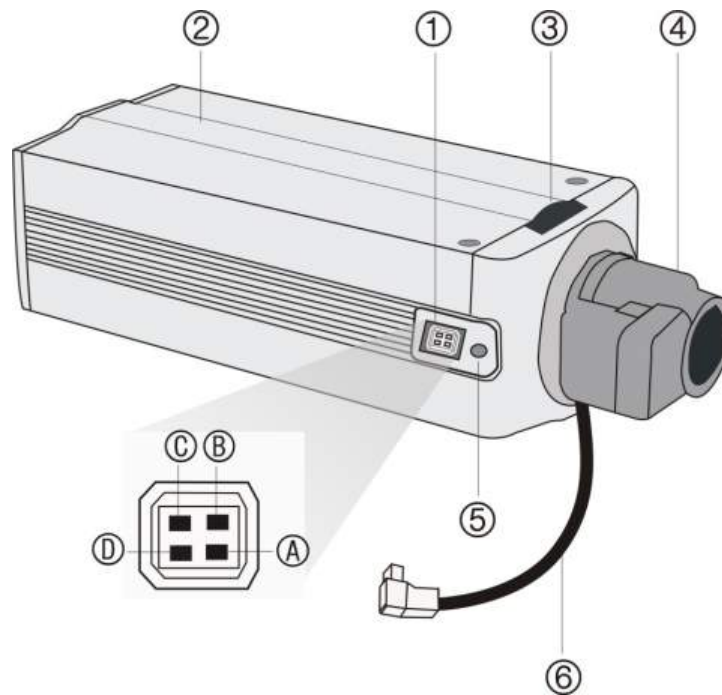

1. Auto iris lens connector

**Video-type auto iris lens connection:**

A. Video (white); B. Power; C. NC;  
D. GND (black)

**DC-type auto iris lens connection:**

A. Driving coil (+); B. Damping coil (+);  
C. Damping coil (-); D. Driving coil (-)

2. Camera

3. Back focus adjustment

4. Lens (auto iris lens shown. Manual lens has  
no cable.) Not included

5. Back focus lock screw

6. Auto iris lens cable. Not included

## Lenses

Attach a manual lens using an auto electronic shutter (AES) lens or attach an auto iris (AI) lens.

## Mounting the camera

To mount the camera, attach the camera to the prepared mounting surface using the appropriate mount.

# Connections

Figure 2: Rear panel of camera

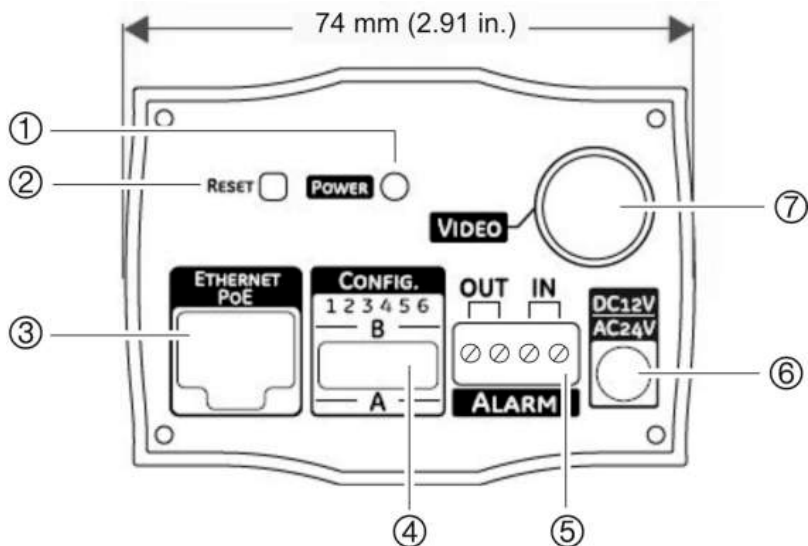

- 1. Power LED.
- 2. Reset button.  
Press to reset camera to factory default settings.
- 3. Ethernet RJ45 port.  
Connect to network devices.
- 4. DIP switches.  
Configure camera settings.
- 5. Alarm input and output.  
Connect to be able to trigger an alarm at the network device.
- 6. Power supply.  
Connect 12 VDC or 24 VDC power supply.
- 7. Video output.  
Connect to a CCTV monitor

## Alarm connection

Figure 3: DC alarm input and output wiring

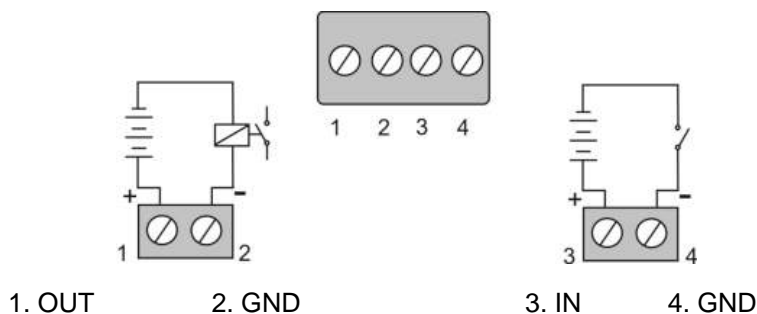

Table 2: Description of alarm connections

Alarm input	
Type	TTL. Compliant with 48 V input voltage.
Connector type	Screw terminal
Alarm output	
Type	Open collector. Compliant with 48 V external power.
Connector type	Screw terminal



## Connecting analog cables

Connect a standard CCTV monitor to the system to adjust the quality of the video image using the DIP switches. The DIP switches can also be adjusted when connected to the IP system.

### To connect the cables:

1. Connect a coaxial cable from the camera's BNC connector to a CCTV monitor or video recording device.
2. Connect a PoE switch, a 12 VDC or 24 VAC power supply to the power input. Do not connect both the PoE connection and DC or AC connection at the same time.

## Setting the camera DIP switches

You can set up six camera functions using the DIP switch bank on the rear of the camera. Figure 4 below shows the DIP switch layout. See "Description of the DIP switch settings" on page 8 for information on these functions.

Figure 4: DIP switch layout (located on rear of camera)

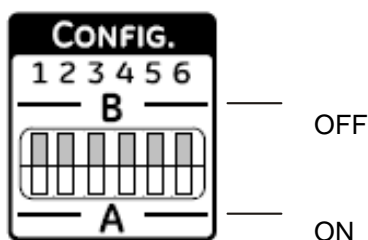

Table 3: DIP switch functions

Switch	Description
1.	White balance ON: ATW mode; OFF: PTL mode
2.	Backlight compensation ON: BLC on; OFF: BLC off
3.	AI/AE exposure ON: Auto exposure (AE) mode; OFF: Auto iris (AI) mode
4.	Day/Night setting ON: Black and white mode; OFF: Auto Day/Night mode
5.	High/Normal Resolution ON: High resolution; OFF: Normal resolution
6.	Flickerless control ON: Flickerless enabled; OFF: Normal

## Description of the DIP switch settings

### White balance (WB)

White balance tells the camera what the color white looks like. Based on this information, the camera will then display all colors correctly.

There are two methods to determine the WB:

- **ATW** (auto tracking white balance). The value used depends on the lighting condition selected. It ensures reliable color reproduction when lighting conditions change frequently.
- **PTL** (push-to-lock) white balance. WB is fixed at the moment the DIP switch is set to ON.

### Backlight compensation (BLC)

The backlight compensation function improves image quality when the background illumination is high. It prevents the object in the center from appearing too dark.

### AI/AE exposure

Use this setting to select the method the camera uses to adjust to different light levels.

### Day/Night

This function controls if the camera switches to day/night mode. The camera produces high-quality color video during the day or when light levels are high. It then switches monochrome and removes the infrared filter to improve IR sensitivity at night or when light levels are low.

### Resolution

High resolution produces higher quality images but also increases the file size of video images.

### Flickerless control

Flickerless control eliminates the flicker caused by the differences between the frequencies (60 Hz) of the ionization of the gas in a fluorescent light bulb with that of the vertical frequency (59.95 Hz) in the camera. Although the difference is very small, it results in a slight flicker at the top of the monitor scene or, in video over IP applications, it would be interpreted as motion. Flickerless control helps reduce the file size and transfer bit rates of compressed video images.

### Reset button

Use this button to reset the camera to factory defaults including camera and network settings. With the camera powered on press the red reset button for 10 to 15 seconds. The red LED indicator light flashes when the reset signal is accepted.

# System configuration

This chapter explains how to configure the camera through a Web browser.

## Software requirements

The UVC-IP camera requires:

- Microsoft Internet Explorer
- A VLC player ActiveX plug-in is required to play video when Internet Explorer is used to monitor the camera.

Figure 5: ActiveX plug-in option

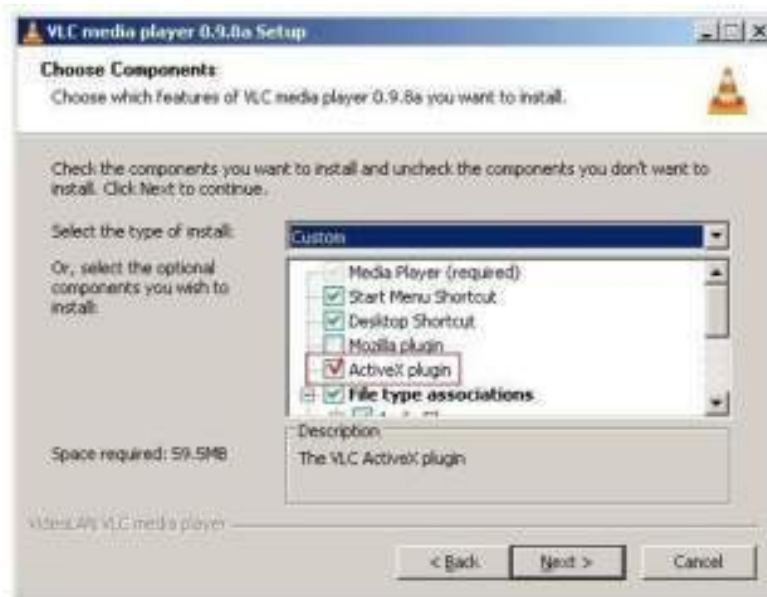

## Windows Vista and 7 users

Internet Explorer for Windows Vista and Windows 7 operating systems have increased security measures to protect your PC from any malicious software being installed.

To have complete functionality of the Web browser interface with Windows Vista and Windows 7, do the following:

- Run the Browser interface and the DVR player application as an administrator in your workstation
- Add the camera's IP address to your browser's list of trusted sites

**To add the camera's IP address to Internet Explorer's list of trusted sites:**

1. Open Internet Explorer.
2. Click Tools, and then Internet Options.
3. Click the Security tab, and then select the Trusted sites icon.
4. Click the Sites button.

5. Clear the “Require server verification (https:) for all sites in this zone” box.
6. Enter the IP address in the “Add this website to the zone” field.
7. Click Add, and then click Close.
8. Click OK in the Internet Options dialog screen.
9. Connect to the camera for full browser functionality.

## Accessing the camera over the internet

The camera can be configured using an internet browser such as Microsoft Internet Explorer (IE).

You must have administrator rights on your PC in order to configure the camera over the internet.

To view camera images via a Network Video Recorder or similar digital video system, please refer to the documentation associated with that system.

### To access the camera online:

1. Configure your host PC/laptop within the same subnet as the camera’s default IP address, for example: 10.1.2.10
2. In the Web browser enter the camera’s default fixed IP address 10.1.2.11. The login dialog box appears.
3. Enter the username and password:  
Login: *admin*  
Password: *admin*
4. Click **OK**. The UltraView IP XP4 box day/night range camera home page appears.

## Overview of monitoring and configuring the system

Use the menu toolbar on the top of every screen to access the various screens for monitoring and configuring the camera. There are five options:

- **Home:** Return to the home page.
- **Live view:** View images in live mode.
- **Monitoring:** Display information on the health of the device, system configuration, video ports and network interfaces. See “Monitoring the system” on page 11.
- **Administration:** Define the network parameters, access rights and video formats. See “Configuring the camera and network” on page 13.
- **Restart:** Restart the device. This is required, for example, to reboot the system for changes to be implemented. However, if the network connection is lost as a result of the configuration changes made, you must reconfigure the

camera by pressing the Reset button on the rear of the camera. The settings return to factory default.

The menu toolbar with these options is displayed along the top of all screens so is always easily available.

## Live viewing

Use this menu option to view live mode. Using the mouse, click the **Live View** option in the menu toolbar.

Click the **Stop** button to stop live view and then the **Play** button to restart it.

You can watch different video streams in live view. However, these must be first set up in the VisioWave CSS system.

## Monitoring the system

Use this menu option to check the status and configuration of the camera and network parameters.

Using the mouse, click the **Monitoring** option in the menu toolbar. The screen displays five icons. By default, the Health Metrics screen is shown. Clicking each icon will list the relevant values underneath.

The system date and time must be set up using a NVR server in order for the date and time to be synchronized.

Click the **Refresh** button on the bottom of the screen to update the information displayed.

Figure 6: Monitoring screen (Health metrics shown)

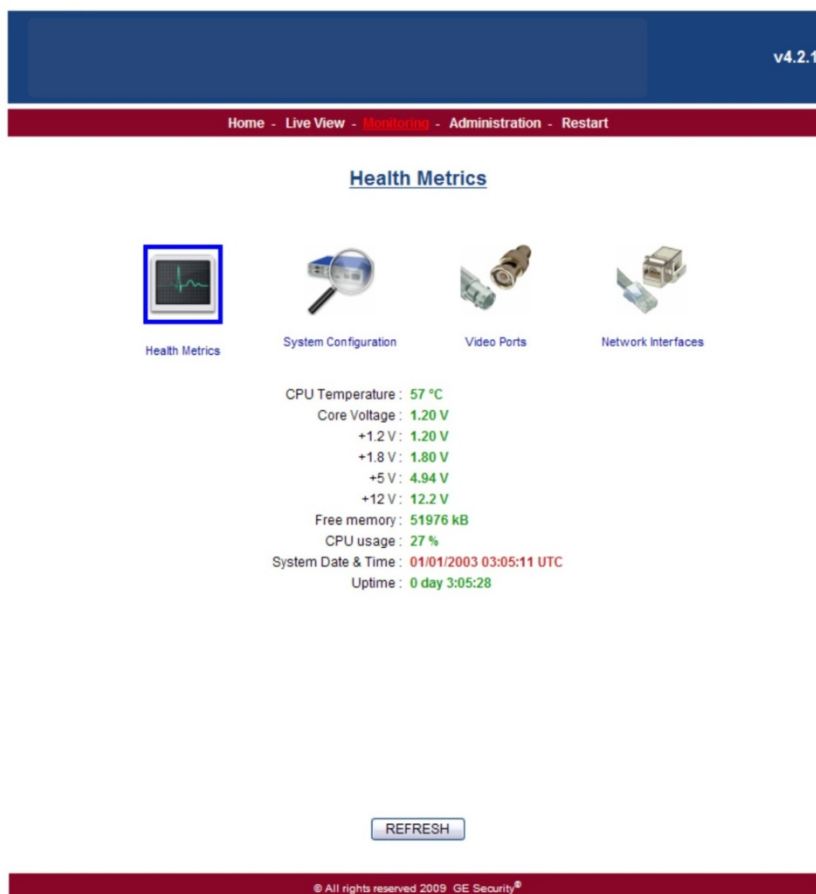





Table 4: Description of the Monitoring screen

Icon	Function	Description
 Health Metrics	Health metrics	Displays the health status of the camera. The items listed are: <ul style="list-style-type: none"> <li>• CPU temperature (°C)</li> <li>• Core voltage</li> <li>• Power supply voltage +1.2 V</li> <li>• Power supply voltage +1.8 V</li> <li>• Power supply voltage +5 V</li> <li>• Power supply voltage +12 V</li> <li>• Free memory</li> <li>• CPU usage</li> <li>• System data and time. A red value means that the device is not synchronized with an NTP server.</li> <li>• Uptime</li> </ul> Values displayed in green are normal. Those in red are abnormal.

Icon	Function	Description
 System Configuration	System configuration	Displays information on the system configuration and status. The items listed are: <ul style="list-style-type: none"> <li>• Equipment name</li> <li>• Serial number of the device</li> <li>• Software revision</li> <li>• U-boot revision</li> <li>• Software recovery revision</li> </ul>
 Video Ports	Video ports	Displays information on the video ports status and configuration. The items listed are: <ul style="list-style-type: none"> <li>• Label</li> <li>• TCP port</li> <li>• Format. Shows PAL or NTCP</li> <li>• Size</li> <li>• FPS. Frame rate</li> <li>• Bandwidth</li> <li>• Status. Normal status is displayed in green. Abnormal status is displayed in red.</li> </ul>
 Network Configuration	Network interfaces	Displays information on the network configuration and status. The items listed are: <ul style="list-style-type: none"> <li>• Type</li> <li>• IP/Mask</li> <li>• Cable status</li> <li>• Tx packets</li> <li>• Tx errors</li> <li>• MAC address</li> <li>• Default Gateway</li> <li>• Ethernet configuration</li> <li>• Rx packets</li> <li>• Rx errors</li> </ul>

## Configuring the camera and network

Use this menu to configure the camera and network parameters.

Using the mouse, click the **Administration** option in the menu toolbar. The screen displays five icons. By default, the Network Configuration screen is shown. Clicking each icon will display a different screen that allows you to configure different parameters. See Figure 7 on page 14.

The system will prompt you to reboot in order for any changes made to take effect. Click **Restart** in the toolbar to reboot the system.

Figure 7: Network configuration screen

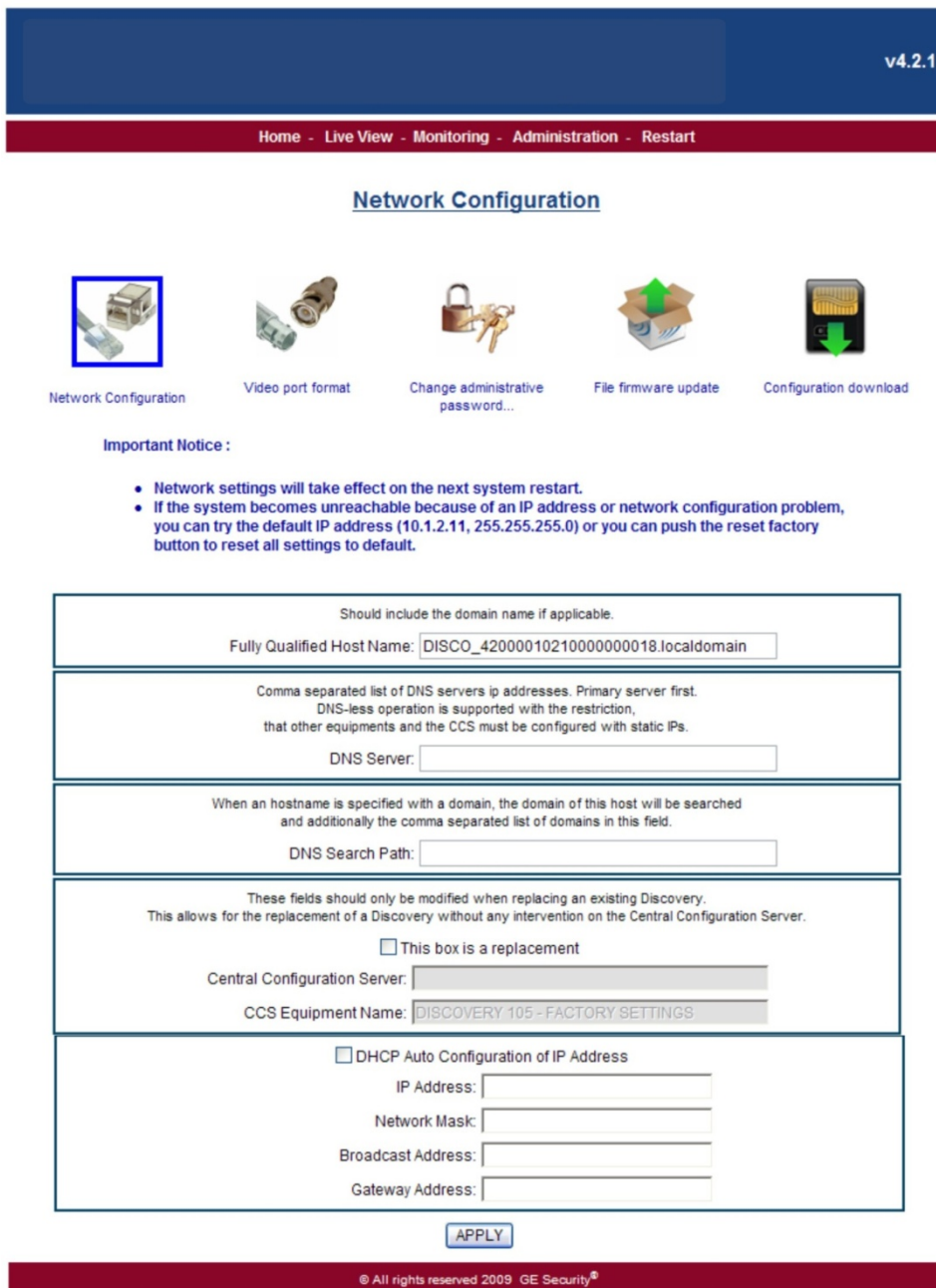







Table 5: Description of the Administration screen

Icon	Function	Description
 <p>Network Configuration</p>	Network configuration	<p>Defines the network parameters.</p> <p>You can assign an IP address either automatically or manually by selecting one of these options:</p> <p><b>DHCP.</b> For automatic installation check the box “DHCP Auto Configuration of IP Address”. This option is disabled by default.</p> <p>— or —</p> <p><b>Static IP.</b> For manual installation enter the IP address, Network mask, Broadcast address and Gateway address values. The default IP address is 10.1.2.11.</p> <p>Click the <b>Apply</b> button to save the changes.</p>



Icon	Function	Description
 <p>Video Ports</p>	Video port format	<p>Defines the video format used, PAL or NTSC.</p> <p>Check one of the format boxes. Click <b>OK</b> to save the changes.</p> <p><b>Note:</b> This parameter is unavailable if the camera has been configured through a Central Configuration Server or VisioWave Security Center.</p>
 <p>Change administrative password...</p>	Change administrative password	<p>Defines the administrative password used to access the system. The factory default admin password is "admin". It is recommended that is this changed for security reasons.</p> <p><b>Note:</b> Keep the admin password in a safe place. If you should forget it, you must reset the camera configurations to default by pressing the Reset button on the rear of the camera.</p> <p>In the <b>Enter old password</b> edit box enter the current admin password. In the <b>Enter new password</b> edit box enter the new admin password and confirm it.</p> <p>Click the <b>Change administrative password</b> button to save the changes.</p> <p>In the menu toolbar then click the <b>Restart</b> option. The Restart screen appears. Click <b>OK</b> to reboot the system to implement the changes.</p>
 <p>File firmware update</p>	File firmware update	<p>Updates the firmware.</p> <p>The camera firmware is stored in the flash memory. Use this option to write the firmware into the flash memory.</p> <p>When you upgrade the firmware, all existing settings are unchanged. Only the new features are added with their default settings.</p> <p>Click the <b>Browse</b> button the locate the updated firmware and then press the <b>Upload firmware file</b> to start the update.</p>
 <p>Configuration download</p>	Configuration download	<p>Lists all the configuration information.</p> <p>You can download it to a file on your computer or another location. Click the <b>Save the configuration</b> button to download this information and enter the download destination.</p>

