



TruVision DVR 11 User Manual

Copyright © 2012 UTC Fire & Security Americas Corporation, Inc.

Interlogix is part of UTC Climate Controls & Security, a unit of United Technologies Corporation. All rights reserved

Trademarks and patents The TruVision name and logo are trademarks of UTC Fire & Security. Other trade names used in this document may be trademarks or registered trademarks of the manufacturers or vendors of the respective products.

Manufacturer UTC Fire & Security Americas Corporation, Inc.
2955 Red Hill Avenue, Costa Mesa, CA 92626-5923, USA
Authorized EU manufacturing representative:
UTC Fire & Security B.V.
Kelvinstraat 7, 6003 DH Weert, The Netherlands

Certification   N4131

FCC compliance **Class B:** This equipment has been tested and found to comply with the limits for a Class B digital device, pursuant to part 15 of the FCC Rules. These limits are designed to provide reasonable protection against harmful interference in a residential installation. This equipment generates, uses, and can radiate radio frequency energy and, if not installed and used in accordance with the instructions, may cause harmful interference to radio communications.

There is no guarantee that interference will not occur in a particular installation. If this equipment does cause harmful interference to radio or television reception, which can be determined by turning the equipment off and on, the user is encouraged to try to correct the interference by one or more of the following measures:

- Reorient or relocate the receiving antenna.
- Increase the separation between the equipment and receiver.
- Connect the equipment into an outlet on a circuit different from that to which the receiver is connected.
- Consult the dealer or an experienced radio/TV technician for help.

European Union directives **12004/108/EC (EMC directive):** Hereby, UTC Fire & Security declares that this device is in compliance or with the essential requirements and other relevant provisions of Directive 2004/108/EC.



2002/96/EC (WEEE directive): Products marked with this symbol cannot be disposed of as unsorted municipal waste in the European Union. For proper recycling, return this product to your local supplier upon the purchase of equivalent new equipment, or dispose of it at designated collection points. For more information see: www.recyclethis.info.



2006/66/EC (battery directive): This product contains a battery that cannot be disposed of as unsorted municipal waste in the European Union. See the product documentation for specific battery information. The battery is marked with this symbol, which may include lettering to indicate cadmium (Cd), lead (Pb), or mercury (Hg). For proper recycling, return the battery to your supplier or to a designated collection point. For more information see: www.recyclethis.info.

Contact information For contact information, see www.utcfireandsecurity.com or www.utcssecurityproducts.eu

Content

Chapter 1	Product introduction 1
	Product overview 1
Chapter 2	Installation 3
	Installation environment 3
	Unpacking the TVR 11 and its accessories 3
	Back panel 4
	Monitor connections 5
	Loop through 6
	Audio inputs and output 6
	RS-485 port 6
	RS-232 port 6
	PTZ dome camera set up 6
	Connecting a KTD-405 keypad and dome camera to the TVR 11 11
	Brackets 12
Chapter 3	Getting started 13
	Turning on and off the DVR 13
	Using the setup wizard 14
Chapter 4	Recording 17
	Initializing the recording settings 17
	Defining a recording schedule 19
	Daily schedules 20
	Holiday schedules 21
	Motion detection schedules 21
	External alarm schedules 21
	Protecting recorded files 22
	Configuring redundant recordings 23
	Capturing text insertions 24
Chapter 5	Alarm settings 25
	Description of alarm notification types 25
	Setting up motion detection 25
	Setting up external alarms 28
	Triggering or clearing alarm outputs manually 30
	Setting up system notifications 30
	Detecting video loss 31
	Detecting video tampering 32
Chapter 6	Network settings 33
	Configuring general network settings 33
	Configuring PPPoE 34

	Configuring DDNS	35
	Configuring an NTP server	36
	Configuring e-mail	36
	Configuring SNMP	37
	Configuring a remote alarm host	38
	Configuring multicast	38
	Configuring the server and HTTP ports	38
	Configuring the RTSP service port	39
	Checking network status	39
	Exporting network packet data	40
Chapter 7	HDD management	41
	Initializing HDDs	41
	Setting the HDD quota	41
	Setting the HDD property	42
	Checking HDD status	42
	Configuring HDD alarms	43
	Checking the S.M.A.R.T. information	43
Chapter 8	Operating instructions	45
	Controlling the TVR 11	45
	Using the front panel	45
	Using the mouse	47
	Using the IR remote control	48
	Menu overview	51
Chapter 9	Live view	55
	Description of live view	55
	Video output	56
	Controlling live view	56
	Single and multiview display formats	57
	Sequencing cameras	58
	Accessing frequently used commands	59
	Configuring live view	61
	Configuring time and date	63
	General settings	64
	V-stream encoding	67
Chapter 10	Controlling a PTZ camera	69
	Configuring PTZ settings	69
	Calling up presets, tours and shadow tours	70
	Setting and calling up presets	71
	Setting and calling up preset tours	73
	Setting and calling up a shadow tour	75
Chapter 11	Playing back a recording	77
	Overview of the playback window	77
	Instant playback	79

	All-day playback	80
	Searching recorded video	81
	Playing back recordings by time and video type	82
	Playing back recordings by event	83
	Slideshow of snapshots	84
	Playing back recordings from the system log	84
	Motion search	86
	Playing back frame-by-frame	87
	Digital zoom in playback	87
Chapter 12	Archiving recorded files	89
	Archiving files	89
	Creating and archiving video clips	91
	Archiving snapshots	92
	Managing backup devices	93
	Playing back archived files on a PC	93
Chapter 13	DVR management	95
	Configuring the RS-232 port	95
	Updating system firmware	96
	Restoring default settings	96
	Viewing system information	97
	Searching system logs for events	98
Chapter 14	Camera settings	101
	Configuring the OSD settings	101
	Setting up privacy masking	102
	Adjusting video image settings	103
Chapter 15	User management	105
	Adding a new user	105
	Customizing a user's access privileges	106
	Deleting a user	108
	Modifying a user	108
	Changing the Admin password	108
Chapter 16	Using the web browser	109
	Windows Vista and 7 users	109
	Accessing the web browser	110
	Web browser overview	110
	Using the web browser to configure the device	112
	Searching and playing back recorded video	113
	Searching for event logs	115
	Controlling a PTZ dome camera in the web browser	115
	Capturing text insertions	116

Appendix A	Specifications	119
Appendix B	PTZ protocols	121
Appendix C	KTD-405 keypad	123
	Supported firmware	123
	Wiring the keypad	123
	Setting up the keypad to work with the TVR 11	124
	Operating the keypad	126
Appendix D	Maximum pre-recording times	131
Appendix E	Supported PTZ commands	133
Appendix F	Default menu settings	135
	Glossary	143
	Index	145

Chapter 1

Product introduction

Product overview

This is the TruVision DVR 11(TVR 11) User Manual for models:

Table 1: Product codes

Americas	Description
TVR-1108-1T	TruVision DVR 11, H.264, 8 ch, 1 TB Storage
TVR-1108-2T	TruVision DVR 11, H.264, 8 ch, 2 TB Storage
TVR-1116-2T	TruVision DVR 11, H.264, 16 ch, 2 TB Storage
TVR-1116-4T	TruVision DVR 11, H.264, 16 ch, 4 TB Storage
EMEA	
TVR-1104-500/EA	TruVision DVR 11, H.264, 4 ch, 500 GB Storage
TVR-1104-1T/EA	TruVision DVR 11, H.264, 4 ch, 1 TB Storage
TVR-1104-2T/EA	TruVision DVR 11, H.264, 4 ch, 2 TB Storage
TVR-1108-1T/EA	TruVision DVR 11, H.264, 8 ch, 1 TB Storage
TVR-1108-2T/EA	TruVision DVR 11, H.264, 8 ch, 2 TB Storage
TVR-1116-2T/EA	TruVision DVR 11, H.264, 16 ch, 2 TB Storage
TVR-1116-4T/EA	TruVision DVR 11, H.264, 16 ch, 4 TB Storage
TVR-1104D-500/EA	TruVision DVR 11, H.264, 4 ch, DVD/CD, 500 GB Storage
TVR-1104D-1T/EA	TruVision DVR 11, H.264, 4 ch, DVD/CD, 1 TB Storage
TVR-1104D-2T/EA	TruVision DVR 11, H.264, 4 ch, DVD/CD, 2 TB Storage
TVR-1108D-1T/EA	TruVision DVR 11, H.264, 8 ch, DVD/CD, 1 TB Storage
TVR-1108D-2T/EA	TruVision DVR 11, H.264, 8 ch, DVD/CD, 2 TB Storage
TVR-1116D-1T/EA	TruVision DVR 11, H.264, 16 ch, DVD/CD, 1 TB Storage
TVR-1116D-2T/EA	TruVision DVR 11, H.264, 16 ch, DVD/CD, 2 TB Storage

Note: Models are shipped with the power cords for their region.

For regions not listed in Table 1 above, please contact your local supplier.

The TruVision™ DVR 11 (TVR 11) is a versatile, user-friendly embedded digital video recorder (DVR) allowing end-users to record 4, 8 or 16 analog cameras at CIF in real time (25/30 fps), while providing integration with the UTC portfolio of security solutions, and offering a seamless product experience within the TruVision brand.

Its dual streaming functionality allows the user to set up different settings for recording and streaming video in live view mode.

TruVision DVR 11 can fully integrate with the license-free TruVision Navigator software, which is ideal for the most commercial applications. TVR 11's easy and intuitive-to-use web browser interface enables remote configuration and secure viewing, searching, and playing back of video from computers connected via the Internet.

Chapter 2

Installation

This section describes how to install the TVR 11 unit.

Installation environment

When installing your product, consider these factors:

- Ventilation
- Temperature
- Moisture
- Chassis load

Ventilation: Do not block any ventilation openings. Install in accordance with the manufacturer's instructions. Ensure that the location planned for the installation of the unit is well ventilated.

Temperature: Consider the unit's operating temperature (-10 to +55 °C, 14 to 131 °F) and noncondensing humidity specifications (10 to 90%) before choosing an installation location. Extremes of heat or cold beyond the specified operating temperature limits may reduce the life expectancy of the DVR. Do not install the unit on top of other hot equipment. Leave 44 mm (1.75 in.) of space between rack-mounted TruVision DVR 11 units.

Moisture: Do not use the unit near water. Moisture can damage the internal components. To reduce the risk of fire or electric shock, do not expose this unit to rain or moisture.

Chassis: Equipment weighing less than 15.9 kg (35 lb.) may be placed on top of the unit.

Unpacking the TVR 11 and its accessories

When you receive the product, check the package and contents for damage, and verify that all items are included. There is an item list included in the package. If any of the items are damaged or missing, please contact your local supplier.

Items shipped with the product include:

- IR (infrared) remote control
- Two AAA batteries for the remote control
- AC power cords
- USB mouse
- DVR
- Video loop through cable
- CD with software and manuals
- *TruVision DVR 11 Quick Start Guide*
- *TruVision DVR 11 User Manual (on CD)*

Back panel

Figure 1 on page 5 shows the back panel connections and describes each connector on a typical TVR 11 digital video recorder. Details may vary for specific models.

Before powering up the DVR, connect the cameras and a main monitor for basic operation. Once all required connections are done, enter the relevant data in the setup wizard (see page 14).

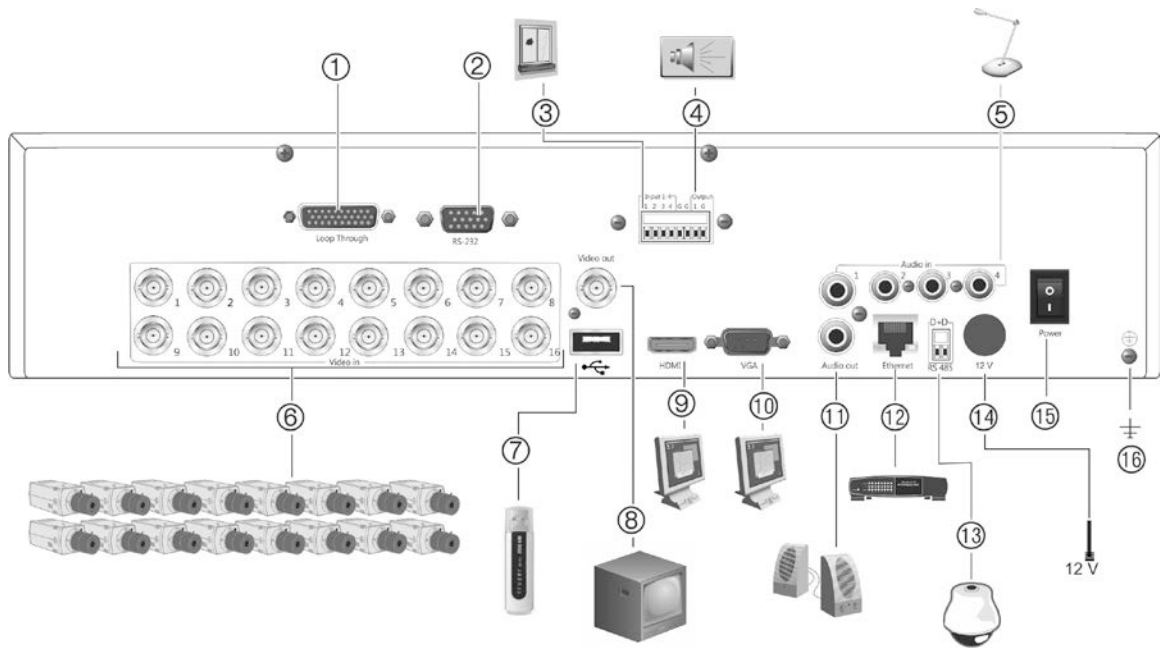
Figure 1: Back panel connections (16-channel model shown)

1. Loop through for up to 16 analog cameras (depends on DVR model).
2. Connect to a RS-232 device.
3. Connect up to four alarm input cables to relay outputs.
4. Connect one alarm relay output.
5. Connect four audio inputs to RCA connectors.
6. Connect up to 16 analog cameras to BNC connectors (depends on model of DVR).
7. Connect to an optional USB device such as a mouse, CD/DVD burner or HDD.
8. Connect one CCTV monitor (CVBS connector).
9. Connect to a HDTV. The HDMI connection supports both digital audio and video.
10. Connect to a VGA monitor.
11. Connect to speakers for audio output.
12. Connect to a network.
13. Connect to a RS-485 device such as a PTZ camera or a keypad.
14. Connect to the PSU (12 VDC).
15. Power switch (on/off).
16. Connect to ground.

Monitor connections

Connect a monitor to one of the DVR's outputs (BNC/VGA/HDMI). The DVR provides a 1 Vp-p CVBS signal. See Figure 1 above for connecting a monitor to a TVR 11.

The TVR 11 supports up to 1280 × 1024 / 60 Hz resolution in VGA. The monitor resolution should be at least 800 × 600. Adjust your monitor accordingly to this resolution.

Loop through

You can loop through the analog cameras to equipment such as a matrix, monitors or a second DVR. The number of loop-through BNC outputs depends on the DVR model. See Figure 1 on page 5.

Audio inputs and output

The unit is equipped with four audio inputs and one audio output. Both the audio output and the audio inputs are line-level.

Audio input	RCA jack, 315 mV, 40 kohms. Unbalanced
Audio output	RCA jack, 315mV, 600 ohms. Unbalanced

Note: Line-level audio requires amplification.

RS-485 port

There is one RS-485 port on the back panel of the DVR to connect a PTZ dome camera or keypad. See Figure 2 for the serial pin outs.

Figure 2: RS-485 pin outs

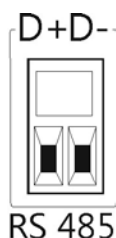

D+: Connect to the RS-485 A connection on the dome camera or keypad.

D-: Connect to the RS-485 B connection on the dome camera or keypad.

RS-232 port

Use the RS-232 port to connect CBR-PB3-POS (point-of-sale) and ATM devices to the DVR such as the UTC ProBridge accessory. See “Configuring the RS-232 port” on page 95 for more information.

PTZ dome camera set up

Use the USB mouse provided or the optional keypad for local telemetry control. If using the TVR 11 over a network, use the web browser to control the PTZ dome cameras or TruVision Navigator.

See Appendix B on page 121 for the supported protocols and Appendix E on page 133 for the PTZ commands supported by each protocol.

Each PTZ camera must be set up individually. For information on configuring PTZ dome camera settings, see Chapter 10, “Controlling a PTZ camera” on page 69.

Connecting a PTZ dome camera

See Figure 3 below for how to connect a PTZ camera to the DVR. Any PTZ dome camera can be controlled as the DVR is doing the PTZ protocol translation. However, this setup provides only limited dome configuration (see Appendix B on page 121 for the list of approved PTZ protocols).

Figure 3: Connecting a PTZ dome camera to the TVR 11 for control over the network

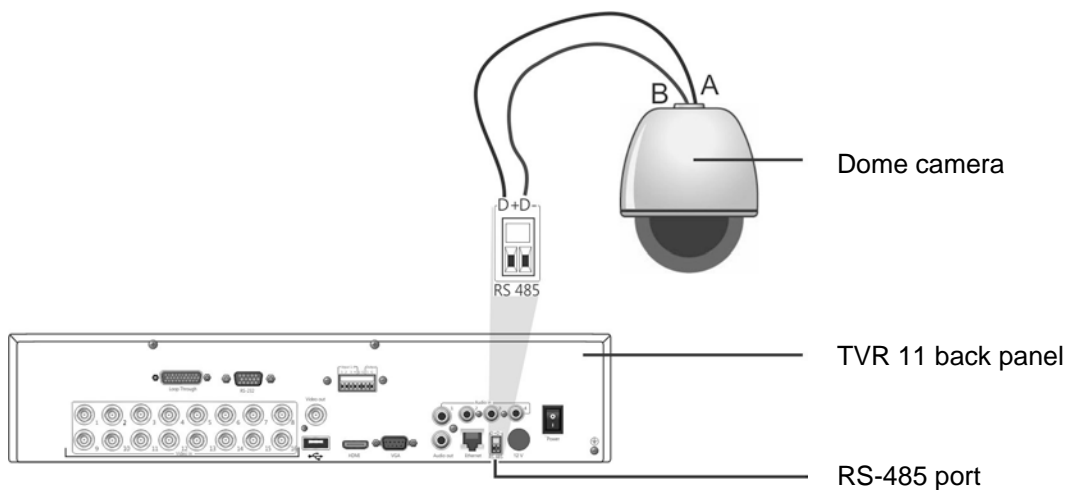

Configuring the PTZ protocols for Interlogix cameras

Before the PTZ dome cameras are assembled in their housings, set their protocol and address DIP switches for the TVR 11. See Table 2 on page 8 for different Interlogix PTZ dome camera settings.

If you are using PTZ dome cameras from another company, please refer to their configuration instructions.

Table 2: PTZ protocols for Interlogix cameras

Camera	Switch setting	
TruVision Mini PTZ 12X: Indoor Dome	Protocol DIP switches:	
	<ul style="list-style-type: none"> • RS-485 (on TVR 11): 000000 • RS-422 (on I/O box): 100000 	
	RS-485 communication DIP switches:	110000
	Camera ID DIP switches:	Select the camera ID DIP switch address as required

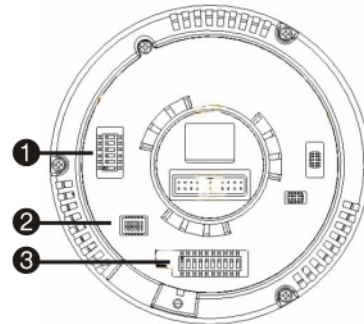

1. Protocol DIP switches
2. RS-485 communication DIP switches
3. Camera ID DIP switches

RS-422/RS-485 data connector:

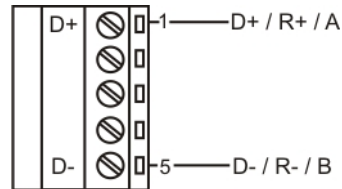

TruVision Mini PTZ 12X: Outdoor Dome	Protocol DIP switches:	
	<ul style="list-style-type: none"> • RS-485 (on TVR 11): 000000 • RS-422 (on I/O box): 100000 	
	RS-485 communication DIP switches:	110000
	Camera ID DIP switches:	Select the camera ID DIP switch address as required.

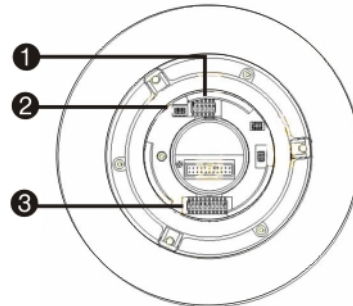

1. Protocol DIP switches
2. RS-485 communication DIP switches
3. Camera ID DIP switches

RS-422/RS-485 data connector:

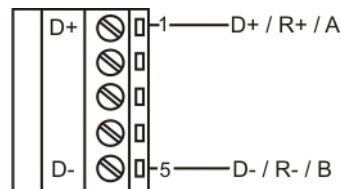

Camera	Switch setting
TruVision Dome 16X PTZ	<p>Protocol switches: 0111</p> <ul style="list-style-type: none"> RS-485 (on TVR 11): RS-422 (on I/O box): 1111 <hr/> <p>Address switches: Select the camera ID DIP switch address as required.</p> <hr/> <p>Baud rate: 0000 = 9600 bps 0011 = 4800 bps</p>

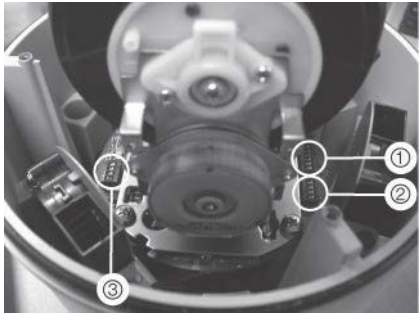

1. Address switches; 2. Baud switches; 3. Protocol switches

RS-422/RS-485 data connector:

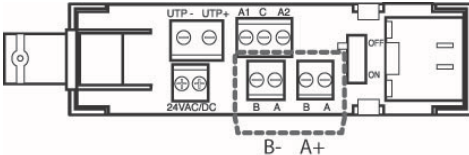

CyberDome	<p>Protocol switches: NA</p> <hr/> <p>Address switches: Select the camera ID DIP switch address as required.</p>	
-----------	--	--

RS-485 data connector:

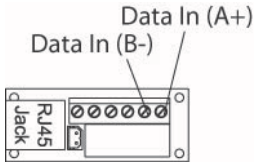

Camera	Switch setting
UltraView PTZ	<p>Protocol switches:</p> <ul style="list-style-type: none"> RS-485 (on TVR 11): 01000 RS-422 (on I/O box): 10000 <p>Address switches: Select the address switch address as required.</p>

1. Protocol switches;
2. Address switches

RS-422/RS-485 data connector:

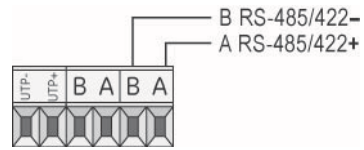

Legend	<p>Protocol switches: 1</p> <ul style="list-style-type: none"> RS-485 (on TVR 11): RS-422 (on I/O box): 0 <p>Address switches: Select the camera ID DIP switch address as required.</p>
--------	---

RS-422/RS-485 data connector:

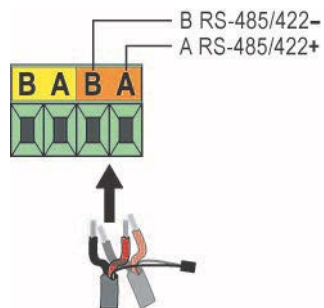

Connecting a KTD-405 keypad and dome camera to the TVR 11

Use the input/output box that is supplied with the keypad to connect the KTD-405 keypad to the TVR 11. See Appendix C on page 123 for more information on wiring and using the KTD-405 keypad.

As the KTD-405 keypad uses full duplex data communication, you cannot connect the both keypad and a dome camera directly to the DVR from the RS-485 port as this could cause problems on the bus. If both devices are required, it is recommended that you use the keypad's RS-422 connection to connect the dome camera and the keypad's RS-485 connection to connect the TVR 11. See Figure 4, Table 3, and Table 4 below.

Note: These connections only work with UTC PTZ protocols (see Appendix B on page 121). If you are using another manufacturer's PTZ protocol, it is not possible to connect both a keypad and dome camera to the TVR 11.

Figure 4: Connecting a PTZ dome camera and KTD-405 keypad to the TVR 11

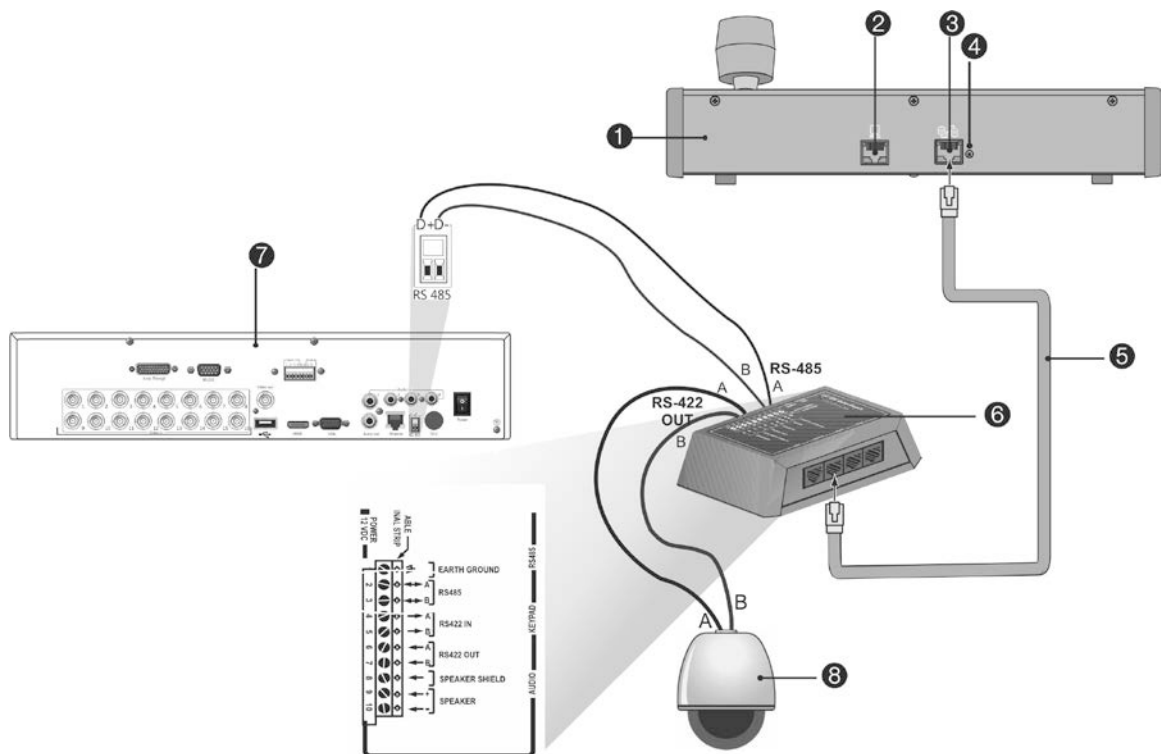

1. KTD-405 keypad
2. RS-232 programming port
3. RS-485 and RS-422 in/out
4. RS-485 termination switch
5. RJ45 cable control (use the cable provided with the equipment)
6. I/O box
7. TVR 11 back panel
8. Dome camera

Table 3: UTC PTZ protocol settings

Dome: RS-422 protocol	TVR 11: Interlogix RS-485
-----------------------	---------------------------

See Table 4 below for the bus addresses to consider when connecting a both keypad and dome camera to the TVR 11.

Table 4: Bus addresses

DVR bus address	DVR video inputs	PTZ address range
1	1-32	00-31
2	1-32	32-63
3	1-32	64-95
4	1-32	96-127
5	1-32	128-159
6	1-32	160-191
7	1-32	192-223
8	1-32	224-255

Brackets

The DVR is easily rack-mountable See Figure 5 below.

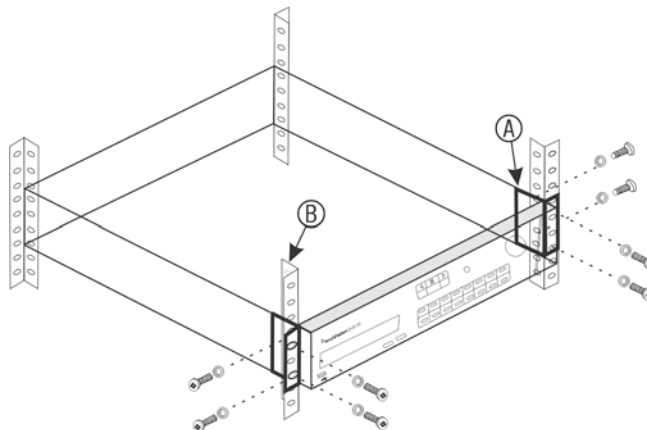
Figure 5: Rack-mount installation

To install the racks:

1. Attach the two small front-rack mount ears (A) to the DVR (supplied).
2. Attach the DVR to the front rails (B) (screws not supplied).

Chapter 3

Getting started

Turning on and off the DVR

Before starting the power up process, connect at least one monitor to the video out or the VGA interface. Otherwise, you will not be able to see the user interface and operate the device. Also connect at least one camera.

The TVR 11 auto-detects the video mode (PAL or NTSC) on startup.

It comes equipped with a universal power supply that will auto-sense 110/240 V, 60/50 Hz.

Note: It is recommended that an uninterruptible power supply (UPS) is used in conjunction with the device.

To turn on the DVR:

Turn on the DVR using the power switch on the back panel. Once the TVR 11 is powered up, the status LEDs on the front panel will light up. All connected cameras are displayed on-screen. The DVR automatically begins recording.

To turn off the DVR:

1. In live view mode, right-click the mouse and click **Menu**. The main menu window appears.
2. Select the **Power Manager** icon.
3. In the Shutdown popup menu, select **Shutdown**. Click **Yes** to confirm shutdown.

To reboot the DVR:

1. In live view mode, right-click the mouse and click **Menu**. The main menu window appears.
2. Select the **Power Manager** icon.
3. In the Shutdown popup menu, select **Reboot**. Click **Yes** to confirm shutdown.

Using the setup wizard

The TVR 11 has an express installation wizard that lets you easily configure basic DVR settings when first used. It configures all cameras simultaneously. The configuration can then be customized as required.

By default the setup wizard will start once the DVR has loaded. It will walk you through some of the more important settings of your DVR.

Any changes you make to a setup configuration page are saved when you exit the page and return to the main wizard page.

To quickly set up the TVR 11:

1. Connect all the devices required to the back panel of the DVR. See Figure 1 on page 5.
2. Turn on the unit using the power switch on the front panel. After the boot up screen, the DVR displays video images on screen.
3. Select the preferred language for the system from the dropdown list and then click **Next**.
4. Enable or disable the option to start the wizard automatically when the DVR is turned on. Click **Next**.

5. Administrator configuration:

Navigate to the Admin Password edit box and click the edit box with the mouse, or press Enter on the front panel or remote control, to display the virtual keyboard. Enter the default admin password, 1234.

Note: You must enter an admin password. To change the Admin password, check **New Admin password** and enter the new password and confirm it.

Caution: It is strongly recommended that you change the password of the administrator. Do not leave 1234 as the default password. Write it down in a safe place so that you do not forget it.

If you should forget the password to your DVR, contact your supplier with the serial number of your DVR to obtain a secure code to reset your DVR.

Click **Next**.

6. Time and date configuration:

Select the desired time zone, date format, system time and system date.

Time Zone	(GMT-08:00) Pacific Time(U.S. & Canada)
Date Format	MM-DD-YYYY
System Date	09-25-2012
System Time	14:01:47

Apply

Previous Next Cancel

Note: The system time and date are visible on screen. However, they do not appear in recordings.

Click **Next** to move to the next page, or **Previous** to return to the previous page.

7. **Network configuration:**

Configure your network settings such as the NIC type, IP address, subnet mask and default gateway. Enter the preferred DNS server address as well as the alternate one to use.

NIC Type	10M/100M Self-adaptive
Enable DHCP	<input type="checkbox"/>
IPv4 Address	192.168.1.82
IPv4 Subnet Mask	255 .255 .255 .0
IPv4 Default Gateway	172 .5 .1 .1
Preferred DNS Server	192.0.0.200
Alternate DNS Server	

Previous Next Cancel

Click **Next** to move to the next page, or **Previous** to return to the previous page.

8. **HDD management:**

Configure your HDD settings as required.

Note: You can set up a drive for redundant recording. See “Configuring redundant recording” on page 23.

After configuring your HDD settings, click **Initialize** and **Next** to move to the next page, or **Previous** to return to the previous page.

9. **Recording configuration:**

Configure your recording settings as required. The settings apply to all cameras connected to the DVR.



Check the **Constant Recording** checkbox for the DVR to record continuously all day. If left unchecked, the DVR will not record.

Check the **TL-Hi** check box and select its image resolution and frame rate.

Check the **TL-Lo** check box and select its image resolution and frame rate.

To record motion detection events, check **Event (Motion)** and select the image resolution and frame rate.

To record alarm events, check **Alarm** and select the image resolution and frame rate.

Under **Camera name** enter the camera name. A soft keyboard will appear to enter the characters.

- When all the required changes have been entered, a page appears showing all the settings.



Click **Finish** to exit the Wizard. The TVR 11 is now ready to use.

For a description of the DVR main menu, see “Menu overview” on page 51.

Chapter 4

Recording

This chapter provides instructions on how to define the recording settings of your DVR. This chapter covers how you can configure your initial recording settings, schedule recordings, protect your recorded files, and set up your HDD for redundancy.

Initializing the recording settings

Before you can set up your DVR to begin recording, you must first configure general recording settings for the analog cameras.

Ensure that the HDD has been installed and initialized before configuring the recording settings. See Chapter 7 “HDD management” on page 41 for more information.

To configure recording settings:

1. Click the **Video Schedule** icon in the menu toolbar.
2. Select **Encoding > Record**.



3. Select the camera you want to configure.

4. Configure the following recording settings:

- **Encoding parameters:** Select one of the stream types: Main stream (TL-Hi), Main stream (TL-Lo), Main stream (Event), Main stream (Alarm), or Substream.
- **Stream type:** Select the type of stream to record, either video or video and audio.
- **Resolution:** Select the resolution of the recording. Options include: 4CIF, 2CIF, CIF, and QCIF.
- **Bit rate type:** Select Constant or Variable.
- **Video quality:** Select the quality at which to record. If “Constant” was selected as the bit rate type, this option is unavailable.
- **Frame rate:** Select the recording frame rate. The options available depend on the resolution selected. Real time (25 fps PAL/30 fps NTSC) is only available when the selected resolution is CIF.
- **Max bit rate mode:** Select the general default or customized option.
- **Max bit rate (kbps):** If the customized maximum bit rate mode was selected, enter the value here. It must be between 32 and 3172 kbps. It is calculated from the frame rate and time required.
- **Pre-record:** This is the time the camera starts recording before the scheduled time or event. Select the time in seconds to start pre-recording before the scheduled time or event.

The maximum pre-recording times available depend on the constant bit rate. See “Maximum pre-recording times” on page 131 for more information.

- **Post-record:** This is the time the camera continues to record after the scheduled time or event. Select the time in seconds to stop post-recording after the scheduled time or event.
- **Auto-delete (day):** Select the number of days after which recorded video from the specified camera is permanently deleted from the HDD. A “day” is defined as the 24-hour period from when the auto delete mode (ADM) was set.

The maximum number of days that can be set is 60. However, the actual number of days permitted depends on the HDD capacity. If the value is set to ‘0’, the option is disabled.

- **Record audio:** Select **Yes** to record sound with the images.

5. Click **Apply** to save the settings.6. If you want to save these parameters to another camera, click **Copy** and select the camera in the pop-up window that appears. Click **OK** and return to the main window.

7. Click the **Capture** tab and configure the settings for captured video, such as snapshots. Click **Apply** to save the settings.
8. Click **Back** to return to live view.

Defining a recording schedule

Defining a recording schedule lets you specify when the DVR records video and under what circumstances. Each camera can be configured to have its own recording schedule.

The schedules are visually presented on a map for easy reference. See Figure 6 below for an example.

Figure 6: Description of the schedule window

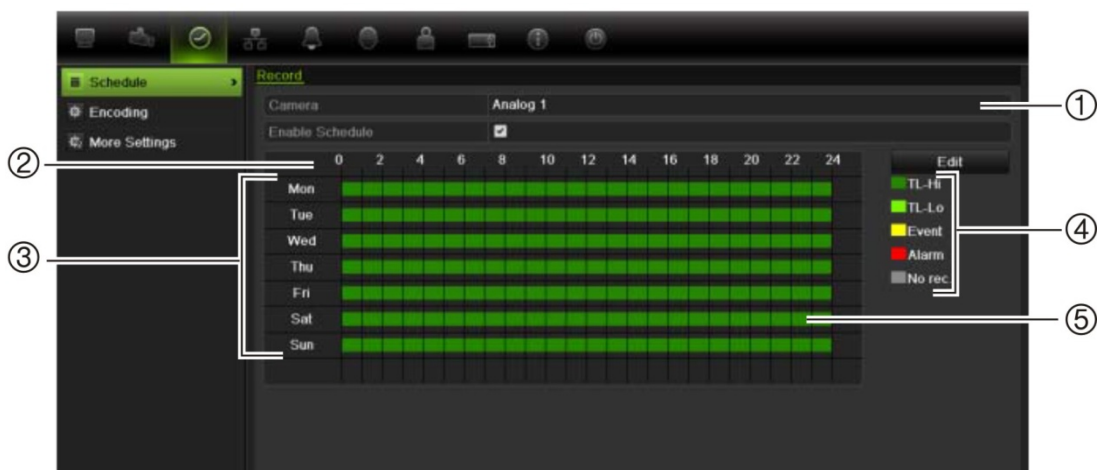

1. **Camera.** Select a camera.
2. **Schedule time.** Represents the 24-hour cycle during which a schedule is selected.
3. **Schedule day.** There are seven days to select: Sunday (Sun), Monday (Mon), Tuesday (Tue), Wednesday (Wed), Thursday (Thu), Friday (Fri), and Saturday (Sat).
4. **Recording type.** There are five recording types to select, which are color-coded:
 - TL Time lapse (Green squares): Record of a specific day. Each green square in the timeline represents an hour in the 24-hour period.
 - TL-Hi (Dark green): High quality time lapse. Records high quality video.
 - TL-Lo (Bright green): Low quality time lapse. Records low quality video. This could be used, for example, for night recordings when few events or alarms are expected. Saving the video in low quality helps save resources on the HDD.
 - Event (Yellow): Records only events, such as motion detection and POS/ATM text insertion.
 - Alarm (Red): Records only alarms.
 - None (Grey): No recording during this period.
5. **Timeline.** There is a 24-hour time line for each day. Up to eight recording periods can be scheduled during the 24-hour period.

Daily schedules

To set up a daily recording schedule:

1. Click the **Video Schedule** icon in the menu toolbar and select **Schedule**.
2. Select a camera.
3. Check the **Enable Schedule** box.
4. Click **Edit**. The following window is displayed:



5. Select the day of the week for which you want to set up the schedule.
You can define a different schedule for each day of the week.
6. Set the start and end time for recording.
Define a time period by entering a start (left column) and end (right column) time. You can schedule up to eight time periods. Click **All Day** to record all day.
Note: Time periods defined cannot overlap.
7. Select a recording type.
This setting instructs the DVR to begin recording when an alarm is triggered. The recording type can be based on time and triggered by motion detection and/or an alarm. If set to TimeLapse (TL-Hi or TL-Lo), the DVR records continuously.
8. Click **Apply** to save settings
9. Repeat steps 4 to 8 for other days of the week or to copy the schedule settings to another day.
To copy the current schedule settings to another day of the week, click **Copy**. Select the number of the day of the week to which to copy the schedule and click **OK** to save changes and return to the Edit window.
10. Repeat steps 4 to 9 for other cameras.
11. Click **Apply** to save the settings and then **OK** to return to the schedule window.

Holiday schedules

As well as being able to schedule when recordings occur during the week, you can also schedule them for specific holidays in the year such as the first of January, or the second Wednesday of every month, for example. You can schedule up to 32 holiday periods.

A holiday period can be scheduled for a particular day or as a block of days.

To set up a holiday recording schedule:

1. Click the **Display Mode Settings** icon in the menu toolbar and select **Holidays**.
2. Select a holiday period from the list and click **Edit** to modify the settings. The Edit window appears.

Holiday Name	Holiday1	
Enable	<input type="checkbox"/>	
Mode	By Month	
Start Date	Jan	1
End Date	Jan	1

3. Enter the name of the holiday period and click **Enable**.
4. Select whether the holiday period will be categorized by date, week or month and then enter the start and end dates.
5. Click **Apply** to save the settings and then **OK** to return to the Edit window.
6. Repeat steps 2 to 5 for other holiday periods.
7. Click **Back** to return to live view.

Motion detection schedules

You can set up both the schedule and areas sensitive to motion detection for each camera individually or easily copy the settings of one camera to other cameras.

For information on scheduling motion detections, see “Motion detection set up” on page 26.

External alarm schedules

The DVR can be scheduled to record when an alarm is triggered by an external alarm device such as a PIR detector or dry contacts. For information on

scheduling external alarms, see “Triggering or clearing alarm outputs manually” on page 30.

Protecting recorded files

There are two methods to prevent recorded files from being inadvertently overwritten or deleted off the HDD. We highly recommend that important recorded events be protected from deletion. Recorded files can either be *locked* or the HDD that the files reside on can be set to *read only*.

Locking and unlocking recorded files

Lock files to protect them against being overwritten or deleted.

To lock or unlock a recorded file:

1. In live view enter the video search window by pressing the **Search** button on the front panel or remote control, and then enter Advanced Search.

— Or —

In live view right-click the mouse to display the pop-up menu and select **Advanced Search**.

The Search window appears.



2. Search for the desired recording by entering the search parameters, which include the camera number, record type, file type, and start time and end time.
3. Click **Search**.

A list of recordings, similar to the figure below, matching the search parameters is displayed.



4. Select the file you want to lock/unlock.

The Locked column indicates whether a file is locked or not.

5. Click  to lock a file. Click again to unlock.
6. Click **Cancel** to return to live view.

Setting the HDD to read-only

When you set an HDD to *read-only*, recorded video files cannot be written to the HDD. If multiple HDDs are used, the DVR automatically records to the next HDD not set to *read-only*.

To set a HDD to read-only:

1. Click the **System Setting** icon in the menu toolbar.
2. Click **Hard Disk** to set up the HDD parameters.
3. Select the HDD you want to set to read-only.
4. Check **Read only**.
5. Click **Apply** to save the settings. The HDD is now read-only.

Note: In order to enable recordings on that particular HDD again, you must set the HDD status back to R/W (Read/ Write).

Configuring redundant recordings

Note: This feature is only available for the 4T models of the DVR.

Setting up HDD redundancy lets your DVR redundantly record a copy of the videos onto multiple drives as a safeguard against losing all your files in case of disk failures. This process is also known as *mirroring*. You must have more than one HDD in your DVR to set up HDD redundancy.

Redundancy significantly reduces the storage capability of the HDDs. As a result you need to double your capacity to record video over a given time.

To set up HDD redundancy:

1. Click the **System Setting** icon in the menu toolbar and select **Hard Disk**.
2. Click the **HDD Information** tab and select the HDD to be used for redundancy and click **Edit**.

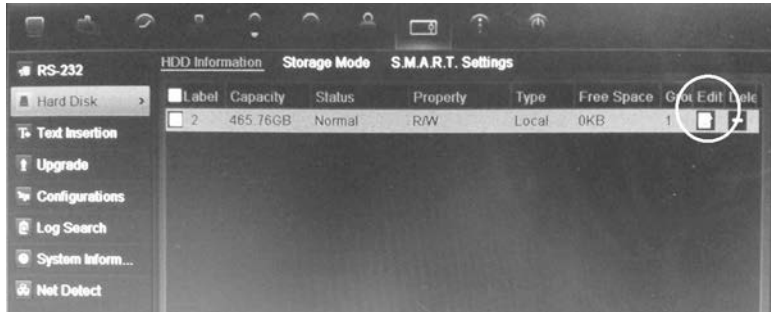

3. In the Local HDD Settings window, select **Redundancy**.
Verify at least one other HDD is set to R/W (read/write).
4. Click **Apply** to save the settings and then **OK** return to the previous window.
5. In the menu toolbar, click the **Video Schedule > Encoding**.
6. Select the camera to be used for redundancy.
7. Check **Redundant Record/Capture**.
8. Click **Apply** to save the settings.
9. Repeat steps 7 to 9 for other cameras whose files you would like to be redundantly recorded.
10. Click **Back** to return to live view.

Note: The HDD set to redundancy stores an extra copy of the recording. When an HDD is set to redundancy, at least one other HDD must be set to the R/W status.

Capturing text insertions

TVR11 supports Point-of-Sale (POS) and ATM text insertion via the UTC ProBridge accessory connected to the RS-232 port on the DVR.

The feature is currently only available via the browser (see “Capturing text insertions” on page 116).

Chapter 5

Alarm settings

This chapter describes setting up how the system will respond when an alarm is triggered.

Description of alarm notification types

When setting up the rules for alarm detection, you can specify how you want the DVR to notify you about an alarm. You can select more than one notification type. Not all notification types are available for all types of alarms.

The alarm notification types are:

- **Audible warning:** Triggers an audible *beep* when a notification or alarm is detected.
- **Notify surveillance center:** Sends a signal to TruVision Navigator or other software applications when an alarm or notification is detected.
- **Trigger alarm output:** Triggers an alarm output when a notification is detected for an external alarm. See “Setting up external alarms” on page 28 for information on configuring an alarm output.
- **Send e-mail:** Sends an e-mail when an alarm or notification is detected. See “Configuring e-mail” on page 36 for information on how to configure the DVR to send an e-mail.

Setting up motion detection

Motion detection is one of the most important features of a DVR. With it there is no need to manually search through hours of video recordings to find an event. The TVR 11 can be set up to trigger an alarm if it detects motion and to record it. You can then search these recorded motion activities for specific incidents. If enabled, motion detection recording can help increase the number of days your DVR can record.

You can mask out any areas of motion on an analog camera display that you do not want to trigger a recording such as a flag on a pole or a moving tree.

Select the level of sensitivity to motion as well the target size so that only objects that could be of interest can trigger a motion recording. For example, recording is triggered by the movement of a person but not that of a cat.

You can set up both the schedule and areas sensitive to motion detection for each camera individually or easily copy the settings of one camera to other cameras.

Motion detection set up

To set up motion detection:

1. Click the **Camera Management** icon in the menu toolbar and select **Motion**.



2. Select the analog camera to detect motion. Each camera must be set up individually.
3. Check **Enable Motion Detection**.
4. Select the areas on-screen to be sensitive to motion.

Click and drag the mouse cursor across the window. The area selected appears as a red grid. Areas covered by the red grid are sensitive to motion detection.

Click **Full screen** to activate the whole screen or **Clear** to clear the screen.

5. Set the sensitivity level.

Drag the Sensitivity scroll bar to the desired sensitivity level. The highest value is on the right of the bar.

6. Specify the target size.

In the Target size option, specify how many grid squares must be activated before motion is detected. Enter a value between 0 and 255 squares.

7. Select the cameras that will record the motion detected.

Click **Rule**. The Rule window appears. Click the **Trigger Channel** tab and select the cameras that will record when a motion alarm is triggered. Click **Apply** to save the settings.



8. Select the recording schedules for motion detection.

In the Rule window, click the **Arming schedule** tab and select the day of the week and the time periods during the day when motion can be recorded. You can schedule up to eight time periods in a day. Default is 24 hours.

Click **Apply** to save the settings. Click **Copy** to copy the settings to other days of the week.

Note: Time periods defined cannot overlap.



9. Select the response method to motion detection.

In the Rule window, click the Rule tab to define the method by which you want the DVR to notify you of the alarm. Click **Apply** to save settings.



10. Click **OK** to return to the motion detection settings window.

11. Click **Back** to return to live view.

To trigger the front panel alarm LED:

1. Click the **Display Settings** icon in the menu toolbar and select **Monitor>More Settings**.
2. Check both the **Other Notification: Panel Alarm LED** and **Motion Alarm** boxes.

Setting up external alarms

The DVR can be configured to record when an alarm is triggered by an external alarm device (for example, PIR detector, dry contacts...).

To set up external alarms:

1. Click the **Alarm settings** icon in the menu toolbar and select the **Alarm Input** tab.



2. Select the alarm input number of a camera and enter the name of the input, if required.
3. Select the alarm input type, NO or NC.
4. Check the **Setting** box to enable the function and click **Rule** to set up the rules for the cameras to be triggered, their alarm schedules, method of alarm notification and PTZ function.
5. Select the cameras to be triggered when an external alarm is detected.

In the Rule window, click **Trigger channel** and select the cameras to be triggered for recording when an alarm is detected. Only analog cameras can be selected. Click **Apply** to save the settings.

6. Select the recording schedules for the external alarm.

Click the **Arming schedule** tab and select the day of the week and the time periods during the day when motion can be recorded. You can schedule up to eight time periods in a day. Default is 24 hours.

Click **Apply** to save the settings. Click **Copy** to copy the settings to other days of the week and holiday period.

Note: The time periods defined cannot overlap.

7. Select the response method to an external alarm.

Click the Rule tab to define the method by which you want the DVR to notify you of the alarm. Click **Apply** to save settings.

8. Select the PTZ camera function required in response to an external alarm.
Select the PTZ camera and the preset, preset tour or shadow tour that is triggered when the alarm is detected.

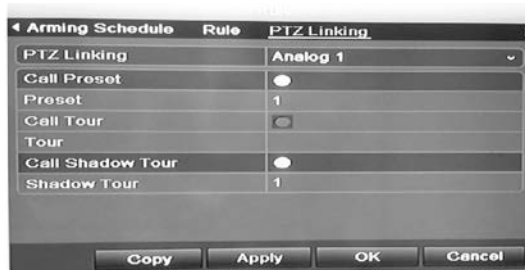

Click **Apply** to save the settings. Click **Copy** to copy the settings to other cameras, if required.

9. Click **OK** to return to the alarm input window.
10. Click **Back** to return to live view.

To set up an alarm output:

1. Click the **Alarm Settings** icon in the menu toolbar and select **Alarm Output**.
2. Select the alarm output.
3. Select a timeout option.

The timeout setting lets you define how long a signal remains active after the alarm has ended. If you select **Manually Clear**, the signal remains active until it is manually acknowledged by pressing the alarm button on the front panel or remote control (see "Triggering or clearing alarm outputs manually" on page 30).

4. Select the recording schedules for the alarm output.

Click **Rule** and select the day of the week and the time periods during the day when motion can be recorded. You can schedule up to eight time periods in a day. Default is 24 hours.

Click **Apply** to save the settings. Click **Copy** to copy the settings to other days of the week and holiday period.

Note: The time periods defined cannot overlap.

5. Click **OK** to return to the alarm output window.
6. Click **Back** to return to live view.

Triggering or clearing alarm outputs manually

When an alarm is activated, the DVR can be set up so that the alarm must be manually acknowledged in order to be silenced. See “Setting up external alarms” on page 28 for information on setting up an alarm to be manually cleared.

All user levels (administrator, manager and operator) can manually acknowledge an alarm.

To trigger or clear alarm outputs manually:

1. Click the **Alarm settings** icon in the menu toolbar and select **Alarm Output**.
2. Click the **Manual Alarm** tab.
3. Select the desired alarm output and click one of the following buttons:
 - **Trigger / Clear:** Trigger an alarm output or stop an alarm output.
 - **Trigger All:** Trigger all alarm outputs at once. This action could be done, for example, when you need to test them.
 - **Clear All:** Stop all alarm outputs at once.
4. Click **Back** to return to live view. The alarm is silenced.

- Or -

1. Press the **Alarm** button on the front panel or remote control. The alarm is silenced.

Setting up system notifications

Setting up system notifications instructs the DVR to alert you when irregular events occur and how to alert you to the event.

You can quickly check the system status by looking at the status LEDs on the front panel. When there is an irregular event with the system, an icon appears on screen to also alert you. See “Status information” on page 55 for further information.

The types of system notifications include:

- **HDD Full:** All installed HDDs are full.
- **HDD Error:** Errors occurred while files were being written to the HDD, no HDD installed or HDD had failed to initialize.
- **Network Disconnected:** Disconnected network cable.
- **IP Conflicted:** Conflict in IP address setting.
- **Illegal Login:** Wrong user ID or password used.
- **Abnormal Video Signal:** Unstable video signal or video loss detected.

- **Input/output Video Standards Mismatch:** I/O video standards do not match.
- **Abnormal Record:** No space on HDD to save recorded files.

See “Description of alarm notification types” on page 25 for information on the different alarm notification types available.

To set up system notifications:

1. Click the **Alarm settings** icon in the menu toolbar and select **Notification**.
2. Select a notification type.
3. Check one or more response options: Audible warning, notify surveillance center, send e-mail, trigger alarm output.
4. Repeat steps 2 and 3 for other notification types.
5. Click **Apply** to save the settings.

Detecting video loss

Video may be lost if the video cable or camera develop a fault or are damaged. You can set up the DVR to detect video loss and trigger a system notification.

To setup video loss detection:

1. Click the **Camera management** icon in the menu toolbar and select **Video Loss**.
2. Select a camera to configure for video loss detection.
3. Check the **Enable Video Loss Alarm** box to enable the feature.
4. Click **Rules** next to the Video Loss Detection box to enter the Rules window.
5. Click the **Rule** tab and select how you want the DVR to notify you of video loss. Click **Apply** to save the settings and then click **OK** to return to the previous window.
6. Click the **Arming Schedule** tab and select the schedule of when you want video loss detection to be enabled. Schedule can be set for all week or any day of the week with up to 8 time periods per day.
7. Click the **Apply** button to save settings.
8. Click **Copy** to copy these settings to other cameras.
9. Click **Back** to return to live view.

Detecting video tampering

You can setup the DVR to alert you when the camera view has changed such as when someone has deliberately blocked the camera view by spraying paint on the lens or by moving the camera. You can set it up so that a specific part of the screen can detect a tamper and thereby trigger an action on the DVR.

Note: It is strongly recommended not to configure for video tampering when using PTZ dome cameras.

To set up video tampering detection:

1. Click the **Camera management** icon in the menu toolbar and select **Tamper-Proof** to display the tamper-proof settings window.
2. Select a camera to configure for video loss detection.
3. Check the **Enable Tamper-proof** box to enable the feature.
4. Define a tampering area.

The tamper detection area setup interface lets you define an area on screen where you want camera tampering to be detected. Click and drag the mouse across an area to mark that area for video tampering. You can only set one tampering area with the full screen being the maximum area. Click **Clear** to clear the window.

5. Select the tamper detection sensitivity level by clicking the sensitivity scroll bar. Higher sensitivity is to the right of the bar.
6. Select the recording schedules for the tamper.

Click **Rule** and then select the **Arming schedule** tab to select the day of the week and the time periods during the day when motion can be recorded. You can schedule up to eight time periods in a day. Default is 24 hours.

Click **Apply** to save the settings. Click **Copy** to copy the settings to other days of the week and holiday period.

Note: The time periods defined cannot overlap.

7. Select the response method to an external alarm.

Click **Rule** and then select the **Rule** tab to select the method by which you want the DVR to notify you of the alarm. Click **Apply** to save settings and then **OK** to return to the previous window.

8. Click **Back** to return to live view.

Chapter 6

Network settings

You must configure your DVR's network settings before using it over the network. The DVR must have access to the internet when configuring the network settings.

Note: As every network configuration may differ, please contact your Network Administrator or ISP to see if your DVR requires specific IP addresses or port numbers.

Configuring general network settings

To configure general network settings:

1. Click the **Network settings** icon in the menu toolbar to display its window.



2. Click **General** and enter the required settings:

Option	Description
NIC type	Network interface card (NIC) is a device used to connect the DVR to a network. Select the NIC type used from the drop-down list. Default value is 10/100M self-adaptive.

Enable DHCP	Check this box if you have a DHCP server running and want your DVR to automatically obtain an IP address and other network settings from that server. Default value is Enable.
IPv4 address	Enter the IP address for the DVR. Default value is 192.168.1.82
IPv4 subnet mask	Enter the subnet mask for your network so the DVR will be recognized within the network. Default value is 255.255.255.0
IPv4 default gateway	Enter the IP address of your network gateway so the DVR will be recognized within the network. This is typically the IP address of your router. Default value is 192.168.1.1
IPv6 address 1	Enter the IPv6 address for the DVR. Default value is fe80::240:3dff:fe7e:926f/64.
IPv6 address 2	Enter the IPv6 address for the DVR.
IPv6 default gateway	Enter the IPv6 address of your network gateway so the DVR will be recognized within the network. This is typically the IP address of your router.
MAC address	Enter the MC address.
MTU (bytes)	Enter a value between 500 and 9676. Default is 1500.
Preferred DNS server	Enter the preferred domain name server to use with the DVR.
Alternate DNS server	Enter the alternate domain name server to use with the DVR.

3. Click **Apply** to save the settings.

Configuring PPPoE

You can connect the DVR directly to a DSL modem. To do this, you need to select the PPPoE option in the network settings. Contact your ISP to get the user name and password.

To configure general network settings:

1. Click the **Network settings** icon in the menu toolbar to display its window.
2. Click **PPPoE** and check the enable PPPoE box.
3. Enter your user name and password and confirm the password.
4. Click **Apply** to save the settings.

Configuring DDNS

A static IP address never changes so you can enter it into the browser or CMS and the DVR network connection will always work with it.

However, if you have a dynamic IP address for your public IP address, it will change every time you connect to the network. Under such situations, you can set up a dynamic domain name system (DDNS) that will link your public IP address to a host name so that you can connect to the DVR with the host name.

There are two ways to set up a DDNS:

- **DynDNS:** Manually create your own host name. You will first need to create a user account using the hosting web site, DynDDNS.org.
- **ezDDNS:** Activate the DDNS auto-detection function to set up a dynamic IP address. The server is set up to assign an available host name to your DVR.

Figure 7: ezDDNS setup window

NAT translates the ports on the server. Consequently there is no need to remember the ports when connecting to the unit from the internet

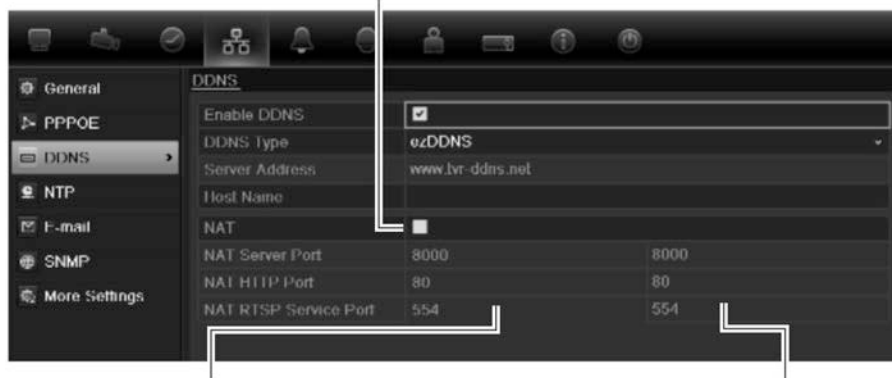

Internal ports

External ports. These values can be modified to access several units over the internet

Note: This option is not shown when using the browser.

Note: You cannot have two DVRs with the same host name.

To set up DDNS:

1. Click the **Network settings** icon in the menu toolbar.
2. Click **DDNS** to display its window.
3. Check the **Enable DDNS** box to enable this feature.
4. Select one of the DDNS types listed:

DynDNS: Select **DynDNS** and enter the server address for DynDNS (members.dyndns.org). In the DVR domain name field, enter the domain name obtained from the DynDNS web site. Then enter your user name and password registered in the DynDNS network.

For example:

Server address: members.dyndns.org

Domain: mycompanydvr.dyndns.org

User name: myname

Password: mypassword

- Or -

ezDDNS: Select **ezDDNS** and enter your domain name. The server type entry is prepopulated (www.tvr.ddns.net). If you will be connecting the unit via the internet, check **NAT**. Change the HTTP and server ports values, if required. The default values are 80 for the HTTP port and 8000 server port.

5. Click **Apply** to save the settings.

Configuring an NTP server

A Network Time Protocol (NTP) server can also be configured on your DVR to keep the date and time current and accurate.

Note: If the device is connected to a public network, you should use a NTP server that has a time synchronization function, such as the server at the National Time Center (IP Address: 210.72.145.44) or europe.ntp.pool.org. If the device is setup in a more customized network, NTP software can be used to establish a NTP server used for time synchronization

To set up an NTP server:

1. Click the **Network settings** icon in the menu toolbar.
2. Click **NTP** to display its window.
3. Check the NTP box to enable feature. It is enabled by default.
4. Enter the NTP settings:
 - **Interval:** Time in minutes to synchronize with the NTP server. The value can be between 1 and 10080 minutes. Default is 60 minutes.
 - **NTP server:** IP address of the NTP server.
 - **NTP port:** Port of the NTP server.
5. Click **Apply** to save the settings.

Configuring e-mail

Your DVR can send e-mail notifications of alarms or notifications through the network.

Note: Ensure that the DNS address has been set up correctly beforehand.

To configure e-mail settings:

1. Click the **Network Settings** icon in the menu toolbar.
2. Click **E-mail** and enter the required settings.

Option	Description
Enable server authentication	Check the box if your mail server requires authentication and enter the login user name and password.
SMTP server	Enter the SMTP server's IP address.
SMTP port	Enter the SMTP port. The default TCP/IP port for SMTP is 25.
Enable SSL	Check the box to enable SSL if it is required by the SMTP server. This feature is optional.
Sender	Enter the name of the sender of the e-mail.
Sender's address	Enter the sender's e-mail address.
Select receivers	Select an e-mail recipient. Up to three receivers can be selected.
Receiver	Enter the name of the receiver of the e-mail.
Receiver's address	Enter the e-mail address of the receiver.
Enable attached snapshot	Check the Attach JPEG File box if you want to send an e-mail with attached alarm images.
Interval	Select an interval range in the Interval box. The interval range represents the time range in between the alarm images being sent. For example, if you set the interval range at two seconds, the second alarm image will be sent two seconds after the first alarm image

3. Click **Test** to the test e-mail settings.

Note: We recommend that you test the e-mail settings after entering values in the e-mail window.

4. Click **Apply** to save the settings.

Note: We recommend that you test the e-mail settings after entering values in the E-mail window.

Configuring SNMP

The SNMP is a protocol used to manage local networks. You can define the SNMP traps that allow information on the DVR status as well as event and alarm notifications to be sent to a surveillance center.

Before configuring this function, you must first install the SNMP software

To configure SNMP protocol settings:

1. Click the **Network settings** icon in the menu toolbar.
2. Click **SNMP** and enter the required settings.

3. Click **Apply** to save the settings.

Configuring a remote alarm host

If a remote alarm host set, the DVR sends a signal to the host when an alarm is triggered. The remote alarm host must have the TruVision Navigator server software installed.

To set up a remote alarm host:

1. Click the **Network Settings** icon in the menu toolbar.
2. Click **More Settings**.
3. Enter Alarm Host IP and Alarm Host Port.

Alarm host IP represents the IP of the remote PC where the Network Video Surveillance software installed. The alarm host port value must be the same as software's alarm monitor port. Default port is 7200.

4. Click **Apply** to save the settings.

Configuring multicast

Setting up multicasting resolves limitation issues when streaming videos through a network access device. A multicast address spans the Class-D IP range of 224.0.0.0 to 239.255.255.255. We recommend that the IP address range of 239.252.0.0 to 239.255.255.255 be used.

To set up multicasting:

1. Click **Network Settings** icon in the menu toolbar and then click **More Settings**.
2. Enter a Multicast IP address.

Note: When adding a device to the Network Video Surveillance software, the multicast address must be the same as the DVR's multicast IP.

3. Click **Apply** to save the settings.

Configuring the server and HTTP ports

You can change the server and HTTP ports from the default settings in the Network Settings window. The default server port is 8000 while that of the default HTTP port is 80.

Note: The server port has a port range of 2000 to 65535 and is used for remote client software access. The HTTP port is used for remote internet browser access.

To change the default ports:

1. Click the **Network Settings** icon in the menu toolbar and then click **More Settings**.
2. Enter the new Com Port and HTTP Port values.

Configuring the RTSP service port

The RTSP (Real Time Streaming Protocol) is a network control protocol designed for use in entertainment and communications systems to control streaming media servers.

To configure RTSP service port:

1. Click the **Network Settings** icon in the menu toolbar and then click **More Settings**.
2. Enter the RSTP ort value. The default value 554.
3. Click **Apply** to save the settings.

Checking network status

You can easily check network traffic in order to obtain information about the DVR such as its linking status, MTU, sending/receiving rate, MAC address, and NIC type.

You can also check the network connection status by testing its delay and packet loss.

To check network traffic:

1. Click the **System Settings** icon in the menu toolbar and then click **Net detect** to display the Traffic window. The information displayed is refreshed once a second.



To check network delay and packet loss:

1. Click the **System Settings** icon in the menu toolbar and then click **Net detect**.
2. Select the **Network Detection Status** tab.
3. Under the section “Network delay, Packet loss test”, enter the destination address and click **Test**.

The test result appears in a pop-up window.

4. If you need to check the current network parameters, click the **Network** button to get an overview.

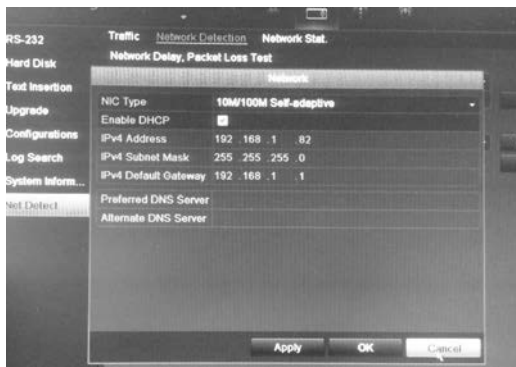

The NIC type and Enable DHCP options can be changed. Click **Apply** to save any changes made.

To check network statistics:

1. Click the **System settings** icon in the menu toolbar and then click **Net detect**.
2. Select the **Network Stat.** tab.
3. The latest information is displayed on the bandwidth used by remote live and playback as well by Net Receive Idle and Net Send Idle. Click **Refresh** to update the information.

Exporting network packet data

When the DVR is connected to a network, you can export the captured data packet to a, USB-flash disk, SATA/eSATA CD-RW and other local backup devices.

To export network packet data:

1. Click the **System Settings** icon in the menu toolbar and then click **Net Detect**.
2. Select the **Network Detection** tab.
3. Under the section “Network packet export”, click **Refresh** to get a list of the local backup devices available. Select one from the list.
4. Click **Export**. Up to 1M of data can be exported at a time.

Chapter 7

HDD management

Initializing HDDs

The in-built HDD must be initialized before it can be used. You can also re-initialize the HDD. However, all data on the HDD will be destroyed.

To initialize a HDD:

1. Click the **System Settings** icon in the menu toolbar and then click **Hard Disk** to display its window.
2. Select the HDD to be initialized.
3. Click the **Initialize** button to begin initialization.



After the HDD has been initialized, the status of the HDD changes from Abnormal to Normal.

Setting the HDD quota

You can allocate on a HDD the maximum permitted storage and snapshot picture capacities from each camera.

1. Click the **System Settings** icon in the menu toolbar and then click **Hard Disk**.
2. Click the **Storage mode** tab.
3. Under the Mode option, select **Quota**.

4. Select a camera whose storage capacity you want to change and enter the values in GB for maximum record capacity and maximum picture capacity. The maximum storage capacity of the HDD is listed.
5. Click **Apply** to save the settings.
6. If you want to copy these values to other cameras, click **Copy** and select the cameras. Click **OK**. Click **Apply** to save the settings.

Setting the HDD property

You can change the behavior of your HDD by changing its property. It can be set to redundancy, read-only or read/write (R/W).

A HDD can be set to read-only to avoid important recorded files from being overwritten when the HDD becomes full.

Note: Before changing the HDD property to “Redundancy”, there must be at least two HDDs installed in the DVR. The redundancy feature is only available in the 4T models of the DVR.

To change a HDD status property:

1. Click the **System Settings** icon in the menu toolbar and then click **Hard Disk**.
2. Click the **HDD Information** tab.
3. Select the HDD whose property you want to change.
4. Click the **Edit** icon . The Local HDD Settings window appears.
5. Click the desired HDD property for the selected HDD.
6. Click the group number for this HDD.
7. Click **Apply** to save and exit the window.

Note: Once set to read-only, the HDD cannot be used to save recorded files until it is set back to read/write (R/W). If the HDD that is currently being written to is set to read-only, the data is then recorded to the next HDD. If there is only one HDD present, setting it to read-only means the DVR cannot record.

Checking HDD status

You can check the status of any of the installed HDDs on the DVR at anytime.

To check the status of a HDD:

1. Click the **System Settings** icon in the menu toolbar and then click **Hard Disk**.

2. Note the status of the HDDs listed under the Status column.

If the status is listed as Normal or Sleeping, the HDD is in working order. If it is listed as Abnormal and has already been initialized, the HDD needs to be replaced. If the HDD is Uninitialized, you need to initialize it before it can be used in the DVR. Refer to “Initializing HDDs” on page 41 for more information.

Note: This information is also available under **System Settings > System Information > HDD** window.

Configuring HDD alarms

HDD alarms can be set to trigger when an HDD is uninitialized or in an abnormal state.

To set HDD alarms:

1. Click the **Alarm settings** icon in the menu toolbar and select **Notification**.
2. Select the notification event to configure under Notification Type box.
3. Select **HDD Full** and check the desired notification method. See “Description of alarm notification types” on page 25 for more information.

Select **HDD Error** and check the desired notification method.

4. Click **Apply** to save the settings.

Checking the S.M.A.R.T. information

S.M.A.R.T. (Self-Monitoring, Analysis and Reporting Technology) reports on a variety of hard drive attributes. It helps ensure that the HDD is functioning properly at all times while protecting video stored on the hard drive.

To view the S.M.A.R.T. information of a HDD:

1. Click the **System Settings** icon in the menu toolbar and then click **Hard Disk**.
2. Select the **S.M.A.R.T.** tab to display its window.
3. Select the HDD whose data you want to see. A detail listing of S.M.A.R.T. information is displayed.



4. If you want to continue to use a HDD when the S.M.A.R.T. test has failed, check the box **Use when the disk has failed to self-evaluate**. Click **Apply** to save the settings.

Chapter 8

Operating instructions

Controlling the TVR 11

There are several ways to control the DVR:

- Front panel control
- Mouse control
- IR remote control
- KTD-405 keypad control (see Appendix C “KTD-405 keypad” on page 123)
- Web browser control

You can use your preferred control method for any procedure, but in most cases we describe procedures using mouse terminology. Optional control methods are given only when they differ substantially from mouse control methods.

Using the front panel

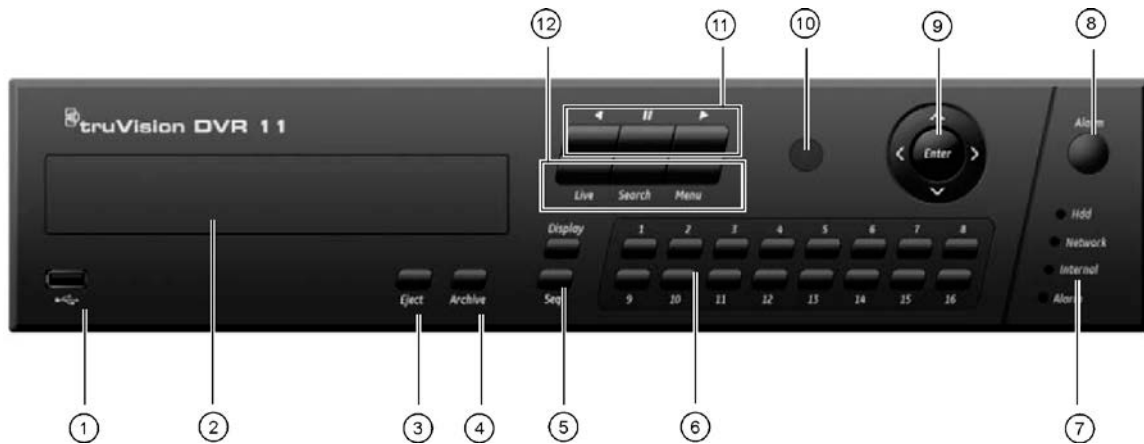

The function buttons on the front panel control can be used to operate many, but not all, of the main functions of the DVR. The LED indicators light up to alert you of various conditions. The functions available can be limited by setting passwords. See Figure 8 on page 46 for more information.

Figure 8: Front panel (16-ch model shown)



The controls on the front panel include:

Item	Name	Description
1.	USB port	Universal serial bus (USB) port for additional devices such as USB mouse and USB hard disk drive (HDD).
2.	CD/DVD burner	Insert CD or DVD disc. The CD/DVD burner is not present on all models. Not all menus are available on models without a burner.
3.	Eject button	Ejects CD/DVD disc.
4.	Archive button	Press once to enter quick archive mode. Press twice to start archiving.
5.	Display and Seq buttons	Live view mode: Press Display to toggle through the various views single and multiviews. Press Seq to start/stop sequencing in live view mode. Menu mode: Press Enter to select a menu window and then Seq to toggle through the tabs along the top of a menu window.
6.	Channel buttons	Switch between different cameras in live view, PTZ control or playback modes.
7.	Status LEDs	HDD: Green indicates the DVR is working correctly. Red indicates a fault. Network: Green indicates the network is working correctly. Red indicates a fault or no network connection. Internal: Green indicates the Watchdog is working correctly. Red indicates that the Watchdog is reporting a fault. Alarm: Green indicates no external alarm. Red indicates an external alarm status or motion.
8.	Alarm button	Use to manually acknowledge an alarm.

Item	Name	Description
9.	Enter and arrows button	<p>Use to select options in a menu and to control playback. Press for Enter.</p> <p>Live view mode: Press Enter to enter/exit PTZ mode. Press the left/right arrow buttons to scroll between the cameras.</p> <p>Menu mode: To enter the menu toolbar, keep pressing the left arrow button until the first menu icon is selected. Then press the left/right arrow buttons to select a menu icon. To select a menu option in the submenu panel or setup menu, press the arrow buttons left/right and up/down to position cursor in the menu window. Press for Enter. See Figure 10 on page 51.</p> <p>Playback mode: Press the left/right arrow buttons to slow down or speed up playback. Press the up/down arrow buttons to jump forwards or backwards by 30 seconds. Press Enter to stop/start playback.</p> <p>PTZ mode: Press the arrow buttons to control the movement of the PTZ dome camera.</p>
10.	IR receiver	Receiver for IR remote.
11.	Playback buttons	<p> : Press to jump back to the oldest available video and start the playback.</p> <p> : Press to pause playback.</p> <p> : Press to start all-day playback of the currently selected camera. If you are in multiview format, only the camera shown in the top-left corner of the multiview is played back.</p>
12.	Live, Menu and Search buttons	<p>Live: Switch to live view mode.</p> <p>Menu: Enter/exit the main menu.</p> <p>Search: Enter the advanced search menu.</p>

Using the mouse

The USB mouse provided with the TVR 11 can be used to operate all the functions of the DVR, unlike the front panel which has limited functionality. The USB mouse lets you navigate and make changes to settings in the user interface.

Connect the mouse to the DVR by plugging the mouse USB connector into the USB port on the back panel or the front panel. The mouse is immediately operational and the pointer should appear.

Note: Use a USB 2.0 or higher mouse.

Move the pointer to a command, option, or button on a window. Click the left mouse button to enter or confirm a selection.

You can purchase a spare mouse by ordering part number TVR-MOUSE-1 TruVision™ DVR Model 11/40/41/60 Mouse.

See Table 5 below for a description of the mouse buttons.

Table 5: Mouse buttons

Item	Description	
Left button	Single-Click	<p>Live view: Select a camera to display the quick access toolbar (see “Accessing frequently used commands” on page 59).</p> <p>Menu: Select a component of a menu, such as a button or an input field. This is similar to pressing the Enter button on the remote/front panel controls.</p>
	Double-Click	<p>Live view: Switch between single screen and multi-screen mode in live/ playback mode.</p>
	Click and Drag	<p>Live view: Drag channel/time bar.</p> <p>PTZ control: Adjust pan, tilt and zoom.</p> <p>Tamperproof, privacy masking and motion detection functions: Select the target area.</p> <p>Digital zoom-in: Drag and select target area.</p>
Right button	Single-Click	<p>Live view: Display menu.</p> <p>Menu: Exit the current menu and return to higher level.</p>
Scroll-wheel	Scroll Up	<p>Live view: Return to the previous window.</p> <p>Menu: Move the selection to the previous item.</p>
	Scroll Down	<p>Live view: Move to the next window.</p> <p>Menu: Move the selection to the next item.</p>

Using the IR remote control

The TVR 11 is supplied with an infra red (IR) remote control unit. Like the mouse, it can be used to operate all of the main functions of the TVR 11.

The IR remote control can be programmed with a unique device ID address so that the controller will only be able to communicate with DVRs with that address. No programming is necessary if using a single TVR 11.

The device ID address only applies when using a remote control and not when using a keypad.

You can purchase a remote control by ordering part number TVR-REMOTE-1 TruVision™ DVR Model 11/40/41/60 IR Remote Control.

Figure 9: IR remote control

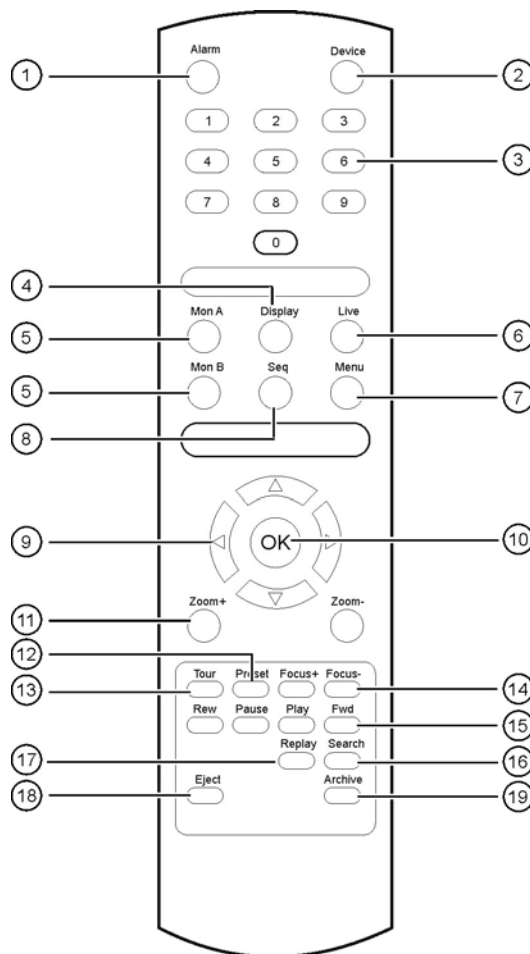

Item	Description
1. Alarm	Acknowledge an alarm.
2. Device	Enable/disable the IR remote control to control the TVR 11.
3. Numeric buttons	Select a camera, and enter a number in a menu option.
4. Display	Switch between the different multiview formats.
5. Mon A and Mon B	Switch between monitors A and B.
6. Live	Return to live view mode.
7. Menu	Activate the main menu.
8. Seq	Start /stop sequencing.
9. <, >, ^, v	In Menu mode: Use left or right arrow buttons to select and up or down arrow buttons to edit entry. In PTZ mode: Use to control PTZ. In Playback mode: Use to control playback speed.
10. OK	Confirm selection.
11. Zoom + and -	Use to control zoom of camera lens.
12. Preset	Enter preprogrammed three-digit code to call up a preset.
13. Tour	Enter preprogrammed three-digit code to call up shadow tour.

Item	Description
14. Focus + and -	Use to control focus of camera lens.
15. Playback control	Use to control playback (Rewind, Pause, Play, and Fast Forward).
16. Search	Open the Search menu.
17. Replay	Replay the selected file from the beginning.
18. Eject	Eject the CD or DVD disk.
19. Archive	Press once to enter quick archive mode. Press twice to start archiving.

Aim the remote control at the IR receiver located at the front of the unit to test operation.

To connect the remote control to the TVR 11:

1. Press the **Menu** button on the front panel or right-click the mouse and select the **Menu** button. The main menu window appears.
2. Click **Display Mode Settings > Monitor**.
3. Check the device address value. The default value is 255. This device address is valid for all IR controls.

Note: The DVR will respond to any remote control that has an address between 1 and 255.

4. On the remote control press the **Device** button.
5. Enter the device address value. It must be the same as that on the TVR 11.
6. Press the **OK** button on the remote control.

To place batteries into the IR remote control:

1. Remove the battery cover.
2. Insert the batteries. Make sure that the positive (+) and negative (-) poles are correctly placed.
3. Replace the battery cover.

Troubleshooting the remote control:

If the IR remote control is not functioning properly, perform the following tests:

- Check the battery polarity.
- Check the remaining charge in the batteries.
- Check that the IR remote control sensor is not masked.

If the problem still exists, please contact your administrator.

Menu overview

The TVR 11 has an icon-driven menu structure that allows you to configure the unit's parameters. Each command icon displays a window that lets you edit a group of settings. Most menus are available only to system administrators.

The window is divided into three sections. The currently selected command icon and submenu item are highlighted in green. See Figure 10 below.

You must be in live view mode to access the main menu.

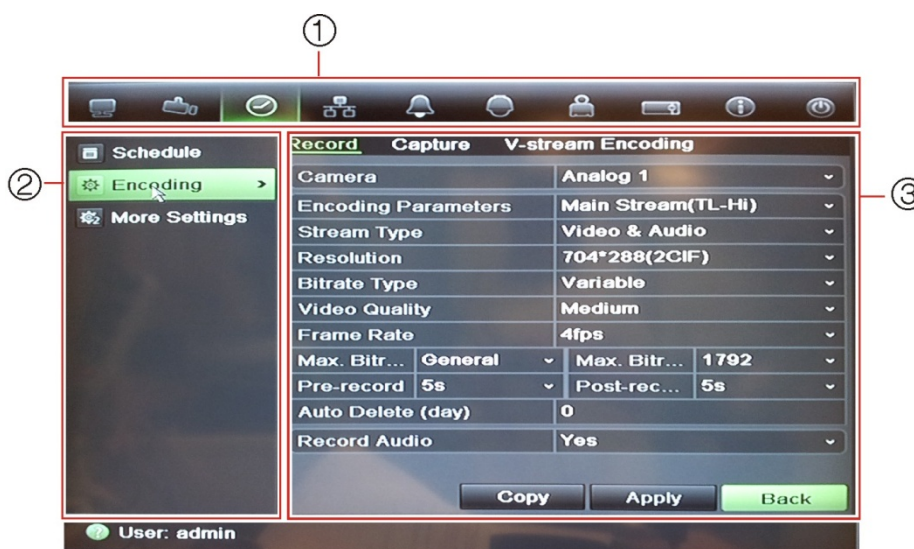

Figure 10: Menu structure









1. **Menu toolbar:** Setup options available for the selected menu function. Move the mouse over a command icon and click to select it. See Table 6 below for a description of the icons.
2. **Submenu panel:** Submenus for the selected menu function are displayed. Click an item to select it.
3. **Setup menu:** All the details for the selected submenu are displayed. Click a field to make changes.

Note: See Figure 8 on page 46 for the description on how to access the menu options using the front panel.

Table 6: Description of the menu toolbar icons

Icon	Name	Description
	Display mode settings	Configures display settings including dwell time, schedule, language and display formats. See "Configuring live view" on page 61 and "Holiday schedules" on page 21.
	Camera management	Configures camera settings including motion detection, video image adjustments, camera title, and copy settings to other cameras. See "Camera settings" on page 95".
	Video schedule	Configures recording settings including recording schedules, record quality, auto delete mode, and recording mode. See Chapter 4 "Recording" on page 17.

Icon	Name	Description
	Network settings	Configures standard network settings including IP address, e-mail notifications, DDNS setup, and advanced network settings. See Chapter 6 “Network settings” on page 33.
	Alarm settings	Configures alarm settings including alarm input, relay output, video loss, remote alert, pre-alarm and post-alarm seconds. See Chapter 5 “Alarm settings” on page 25.
	PTZ settings	Configures PTZ settings. See Chapter 10 “Controlling a PTZ camera” on page 69.
	User management	Configures users, passwords, and access privileges. See Chapter 15 “User management” on page 105.
	System settings	Configures system settings including system date and time, audio output, device name, RS-485 settings, RS-232 settings, firmware upgrade, hard drive settings, boot log, and shutdown. See Chapter 7 “HDD management” on page 41 and Chapter 13 “DVR management” on page 95.
	Help information	Provides reference information to the various toolbars, menus, and keys within the interface.
	Power manager	Provides access to logout, reboot and shutdown options. See “Turning on and off the DVR” on page 13.

To access the main menu:

1. In live view press the **Menu** button on the remote control or front panel.

- Or -

Right-click the mouse and select **Menu** from the pop-up menu.

The main menu window appears. The Display window appears by default.

2. Click the required menu icon to display its submenu options. Modify the configuration parameters as required.
3. Click **Apply** to save the settings.
4. Click **Back** to return to live view.







Using the soft keyboard

A keyboard will appear on-screen when you need to enter characters in a window option. Click a key to input that character.

Figure 11: The soft keyboard

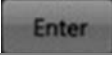

Description of the keys in the virtual keyboard:

	Switch to lowercase/uppercase
	Space
	Exit the soft keyboard
 	Alphanumeric characters
	Backspace
	Symbols
	Confirm selection

Exiting the main menu

Press the **Menu** button on the front panel to exit the current menu window and return to live view, or click **Back** in a main menu.

Chapter 9

Live view





Description of live view

Live view mode is the normal operating mode of the unit where you watch live images from the cameras. The TVR 11 automatically enters into live view mode once powered up. On the viewer you can see whether a recording is in progress and, if set up to do so, the current date and time, as well as the camera name.

Status information

Information on the system and camera status is displayed as icons on the main and auxiliary monitors. The camera status icons are shown for each camera. Each icon represents information on a specific item. These icons include:

Table 7: Description of the on-screen status icons

Icon	Description
	Indicates a sensor alarm.
	Indicates recording (such as manual recording, motion detection or alarm-triggered recording).
	Indicates a motion detection event.
 Video Loss	Indicates a video loss event.
	Indicates alarm and system notifications. Clicking the icon opens a window that lists the alarms and notifications.

The DVR can display more than one icon at the same time. See “General settings” on page 64 to display or hide these icons.

The system status is displayed on the front panel by the status LEDs.

Video output

The DVR automatically checks the monitor outputs used. If more than one monitor is connected, it then defines which monitor is the main one and which is the event one. The event monitor is used to display detected events such as motion. Only one monitor can be controlled at a time.

If a HDMI monitor is used, it will be the main output. If HDMI and VGA monitors are both connected to the DVR, both will be main monitors; they will both show the same view. However, you will not be able to control each individually.

See “Controlling live view” on page 56 for more information on setting up the monitors.

Controlling live view

Many features of live view can be quickly accessed by placing the cursor on a live image and clicking the right-button of the mouse. The mouse menu appears (see Figure 12 below).

Figure 12: The mouse menu for the main monitor



The list of commands available depends on which monitor is active; main or auxiliary (monitor B). See Table 8 below. The default settings of these commands are provided in Appendix F, “Default menu settings” on page 133.

Table 8: Mouse menu for monitor A (main monitor)

Item	Name	Description
1.	Menu	Enter the Main menu. This option is not available from monitor B.
2.	Single camera	Switch to a full-screen view for the selected camera from the dropdown list.
3.	Multi camera	Switch between the different multiview options from the dropdown list.

Item	Name	Description
4.	Previous screen	Displays the previous camera.
5.	Next screen	Displays the next camera.
6.	Start auto-switch	Turn on sequence mode. The window automatically sequences between cameras. See “Multiview” on page 58. Go to Menu > Display Mode Settings > Layout > Dwell Time to set up.
7.	All-day playback	Playback the recorded video of the selected day from the selected camera. The current day is selected by default. See “All-day playback” on page 80 for more information.
8.	Monitor B	Switch between monitors A (main) and B (event).
9.	Advanced search	Enter the advanced video search menu. See “Searching recorded video” on page 81 for more information.
10.	Close time bar	Open/close the time bar.

Table 9: Mouse menu for monitor B (event monitor)

Item	Name	Description
1.	Single camera	Switch to a full-screen view for the selected camera from the dropdown list.
2.	Multi camera	Switch between the different multiview options from the dropdown list.
3.	Previous screen	Displays the previous camera.
4.	Next screen	Displays the next camera.
5.	All-day playback	Playback the recorded video of the selected day from the selected camera. The current day is selected by default. See “All-day playback” on page 80 for more information.
6.	Monitor A	Switch between monitors A (main) and B (event).

Single and multiview display formats

The DVR has single-view display format as well as four multiview formats.

Single view display format

Press the numeric button on the front panel to switch to the corresponding camera display. For example, press button 10 to view camera 10.

Right-click the mouse and select **Single Camera** from the menu. Select the camera required from the list.

Multiview display format

A video tile is any cell in a multiview display. A camera image can only be shown in one video tile at a time. The number of multiview display formats available depends on the DVR model. See Figure 13 on page 58.

To change the multiview display that appears by default, go to the Display menu. See “Changing the camera sequence” on page 62 for more information.

Figure 13: Multiview display formats

4-channel DVR:

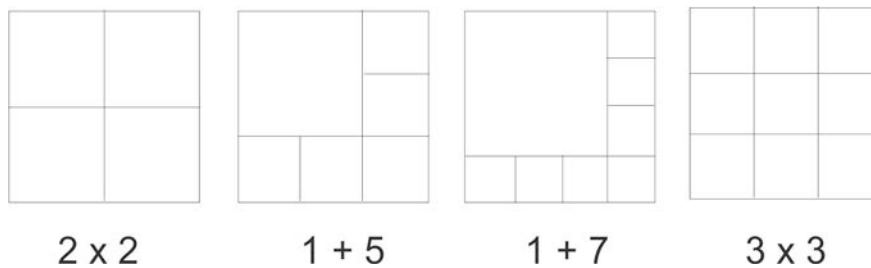

8/16-channel DVR:

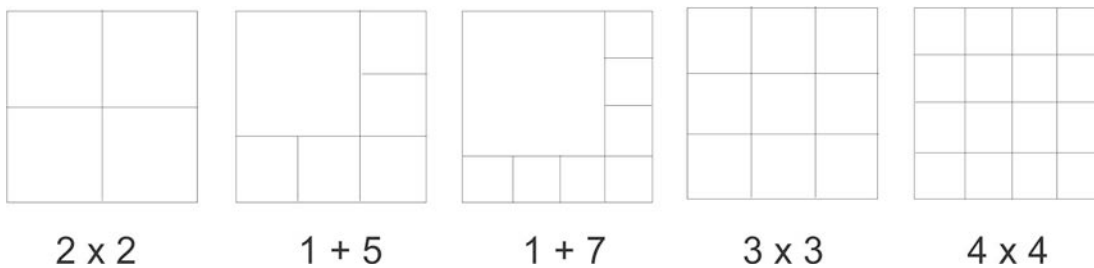

To select a multiview display format:

1. Press the Display button on the front panel to cycle through different display formats.

You can also right-click the mouse and select **Multi Camera** from the menu. Select the desired multiview display layout.

Sequencing cameras

The sequencing feature allows a camera to be displayed briefly on screen, before advancing to the next camera in the sequence list. Sequencing can only be done in single-view display mode.

The default sequence displays each camera in numerical order. However, each camera on the main and auxiliary monitors can have a pre-programmed dwell time and sequence order. See “Changing the camera sequence” on page 62 for more information.

Note: Dwell time must not be set to zero for sequencing to function.

Sequencing live view mode using the front panel:

1. Select the camera where you want to start sequencing.
2. Press the **Seq** button on the front panel to start sequencing.
3. Press the **Seq** button again to stop the sequencing.

Sequencing live view mode using the mouse:

1. Select the camera where you want to start sequencing.
2. Right-click the mouse and select **Start auto-switch** to start the sequencing.
3. Right-click the mouse and select **Stop auto-switch** to stop the sequencing.

Accessing frequently used commands

The quick access toolbar in live view lets you quickly access regularly used commands. Position the cursor over a video image and left-click the mouse. The toolbar appears (see Figure 14 on page 59).

Figure 14: Quick access toolbar

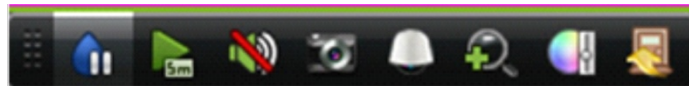











Table 10: Description of the quick access toolbar icons

Icon	Description
	Freeze: Freeze the live image of the selected camera. Although the image pauses, time and date information does not. The system clock continues to run.
	Instant playback: Playback the recorded video from the last five minutes. If no recording is found, then there was no recording made in the last five minutes. Click the icon and select the desired camera. Click OK. See "Instant playback" on page 79 for more information.
 	Audio: Enable/Disable audio output. The audio option must already have been setup in the Display menu.
	Quick snapshot: Capture a snapshot of a video image. The image is saved on the unit. See "Slideshow of snapshots" on page 84 for more information.
	PTZ control: Enter PTZ control mode. See "Configuring PTZ settings" on page 69 for more information.
	Digital zoom: Enter digital zoom. See "Digital zoom" on page 60 for further information.

Icon	Description
	<p>Image settings: Enter the image settings menu to modify the image lighting levels. There are two options:</p> <p>Preset Mode: These are preconfigured image lighting levels. Select one of the four options depending on current lighting conditions:</p> <ul style="list-style-type: none"> - <i>Standard:</i> Use in standard lighting situations. - <i>Indoor:</i> Use indoors. - <i>Dim Light:</i> Use when the light level is low. - <i>Outdoor:</i> Use when outdoors. The contrast and saturation values are high. <p>Customize: Modify brightness, contrast, saturation, and hue values. Click Restore to restore image settings to previous values.</p> <p>Click Restore to restore image settings to previous values.</p> <p>These settings can also be modified from the Camera>Image menu (see page “Adjusting video image settings” on page 103.</p>
	<p>Close toolbar: Close the shortcut toolbar.</p>

Digital zoom

You can easily zoom in or out of a camera image in live view mode and playback using the digital zoom command. The zoom command magnifies the camera image four times. See Figure 15 below.

Figure 15: Digital zoom window

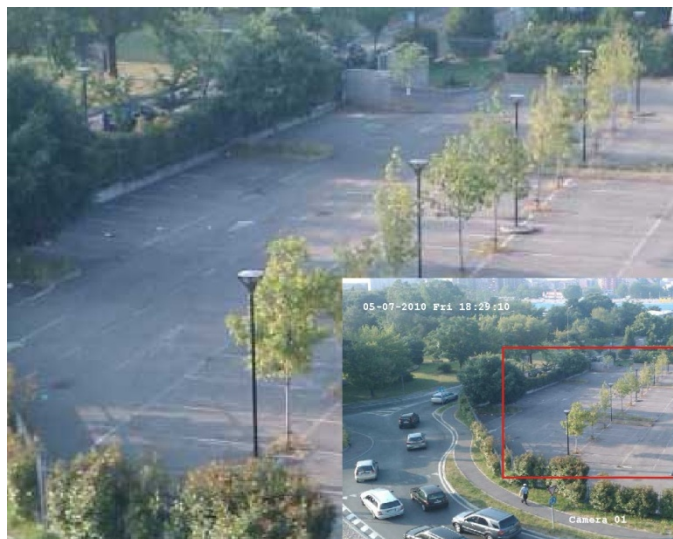

To quickly zoom in/out on a camera image:

1. Select the camera you wish to use.
2. Left-click the mouse and select the digital-zoom icon. The digital view window appears.

3. Left-click the mouse and drag the red square to the area of interest, or press the arrow button on the front panel to position the red square. The selected area is magnified.
4. To exit digital zoom, right-click the mouse.

Configuring live view

The setup of live view can be modified from the main menu to suit different needs, such as the different monitors, multiview layout, and dwell time options. You can also enable audio output.

In the Layout menu use the *Video output interface*, *Live view mode*, *Dwell time*, and *Enable audio output* settings to configure the main monitor. Use *Event output* and *Full screen monitoring dwell time* settings to configure the event monitor.

Figure 16: Layout window (General tab)



Table 11: Description of the layout window

Submenu name	Description
Video output interface	Select which monitor will be the main monitor: HDMI/VGA, or main CVBS. Default is HDMI/VGA, if connected.
Live view mode	Select which multiview layout will be default in live view mode. The factory default multiview format displays all channels (3x3 layout for the 4-channel DVRs and 4x4 layout for the 8/16-channel DVRs).
Dwell time	Set the length of time for which a camera image is displayed on the selected monitor before moving to the next camera during sequencing. Default is off ("No switch").

Submenu name	Description
Enable audio out	You can hear audio from cameras in both live and playback mode. However, in order to be able to hear audio in playback you must enable the audio output setting. Check the box to enable/disable audio output.
Event output	Select which monitor will be the event monitor: HDMI/VGA, or main CVBS. Default is main CVBS.
Full screen monitoring dwell time	Set the length of time for which an alarm event appears on the event (B) monitor before moving to the next camera during sequencing. Default is 10 seconds.
Audio output bound to	Select from which monitor (main or event) audio can be heard.

To set up the display options:

1. Click the **Display Mode Settings** icon in the menu toolbar.
2. Select **Layout > General**.
3. Specify the desired settings for each of the menu options.
4. Click **Apply** to save the settings.
5. Click **Back** to return to live view.

Changing the camera sequence

The cameras are sequenced in numeric order by default. You can change the sequence order of the cameras for all monitors.

You can switch the channel of a camera with that of another camera in the system. This lets you, for example, have the images of camera 1 appear on channel 10, and the images of camera 10 appear on channel 1. This feature is useful when you want to watch the sequence of images from specific cameras so that they are next to each other on-screen.

See Figure 17 below. Each video tile displays both the order of the camera in the sequence and the camera number.

Figure 17: Camera layout and sequence window (4-channel DVR shown)

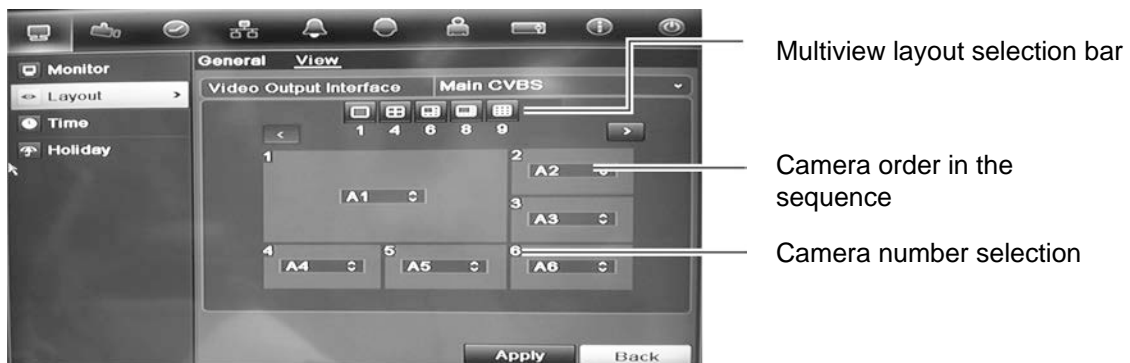

To set the camera sequencing:

1. Click the **Display Mode Settings** icon in the menu toolbar.
2. Select **Layout > View**.
3. From **Video Output Interface**, select the desired monitor from the drop-down list.
4. From the multiview layout selection bar, select the desired multiview layout.
5. Select the video tile of the camera whose order you want to change. The selected tile is highlighted green.
6. In the selected tile, select the new camera sequence order by scrolling through the list of available camera numbers.

Note: “X” means that the camera is not displayed.

7. Click **Apply** to save the settings.
8. Click **Back** to return to live view.

Configuring time and date

You can set up the date and time that will appear on-screen as well as on time stamped recordings. The start and end time of daylight savings time (DST) in the year can also be set. DST is deactivated by default. See Figure 18 below for the Time settings screen.

Figure 18: Time and date settings window



Table 12: Description of the Time and date settings window

Option	Description
Time zone	Select the time zone of the DVR from the drop-down list.
Date format	Select the date format from the drop-down list. Default format is DD-MM-YYYY.
Time format	Select the time format from the drop-down list. Default format is 24-hour format.
Display week	Display the day of the week in the monitor time bar. Check the box to enable/disable. Default format is Disable.
System date	Define the system date. Default date is the current date.
System time	Define the system time. Default time is the current time.
Auto DST adjustment	Define DST is automatically. It depends on the time zone selected. Default format is Disable
Enable DST	Manually define DST. If this option is selected, the <i>Auto DST adjustment</i> option is disabled. Default format is Disable. Click the check box to enable or disable daylight savings time (DST).
From	Enter the start date and time for daylight savings.
To	Enter the end date and time for daylight savings.
DST bias	Set the amount of time to move DST forward from the standard time. Default is 60 minutes.

To set up the system time and date:

1. Click the Display Mode Settings icon in the menu toolbar.
2. Select Time. Modify the required settings.
3. Click the Apply button to immediately implement the changes.

General settings

Use the Display mode settings menu to configure general DVR options on how information is displayed and accessed such as:

- Change GUI language
- Change the DVR name and address
- Define the monitor resolution
- Enable/disable the login password requirement
- Enable/disable the Wizard

- Manually change the video output format (PAL/NTSC)
- Change the time out period after which the display reverts to showing live view
- Enable/disable the transparency of the menus on screen
- Enable/disable whether the status icons appear on screen

See Figure 19 and table Table 13 on page 65 for the general options available, and Figure 20 and Table 14 on page 66 for further options.

The changes are immediately implemented once Apply is clicked to save the settings.

Figure 19: Monitor setup window: General settings



Table 13: Description of the Monitor setup window: General settings

Option	Description
Language	Define the language of the system. Select the desired language from the drop-down list and click Apply . The language displayed changes immediately.
Device name	Define the DVR name. The default name is TVR 11. Click the edit box and enter the new name from the soft keyboard.
Device address	The device number to use for the DVR when programming the remote control or keypad. The default value is 255.
Zone ID	Each DVR in a daisy chain must have a unique zone ID so that it can be controlled by a KTD-405 keypad. The default value is 1.
Resolution	Define the resolution of the selected monitor. Select one of the options from the drop-down list and click Apply . The selected resolution must be the same as that of the monitor.
Password required	Define whether a login password is required. Check the box to enable/disable, and click Apply .
Scaling output video	Enable/disable the monitor display of the main and auxiliary monitor size to accommodate for differently sized monitors. Check the box to enable/disable, and click Apply .

Option	Description
Enable wizard	Define whether the wizard tool starts when the DVR is turned on. Check the box to enable/disable, and click Apply .

Figure 20: Monitor setup window: More settings



Table 14: Description of the Monitor setup window: More settings

Option	Description
Monitor standard	The TVR 11 can support NTSC or PAL video output. The video standard used is auto detected but can be manually changed. Modify the video standard used to PAL or NTSC, and click Apply .
Output mode	Define the desired output mode. Select one of the options from the drop-down list: Standard, Bright, Gentle, or Vivid, and click Apply .
Monitor brightness	Modify the video output brightness. Adjust the scroll bar point to the desired level and click Apply .
Event hint	Define whether the status icons appear on screen. See “Status information” on page 55 for more information. Check the box to enable/disable, and click Apply .
Timebar transparent	Define the transparency of the monitor output time bar on screen relative to the background to make the time bar easier to read. Check the box to enable/disable, and click Apply .
Enable timebar	Define whether the monitor output time bar appears on screen. Check the box to enable/disable, and click Apply .
Menu timeout	Define the time in minutes after which the menu window reverts to live view mode. Select a time from the drop-down list, and click Apply .
Mouse pointer speed	Modify the speed of the mouse pointer. Adjust the scroll bar point to the desired level, and click Apply .

V-stream encoding

If the available bandwidth is limited, you can remotely view several channels in real time with one stream over the web browser or CMS (Client Management System), such as TruVision navigator, using the V-stream encoding option (“V” stands for “virtual”). When enabled, you can see the output from the cameras on a CVBS monitor in one stream.

To enable V-streaming:

1. Click the **Video Schedule** icon  in the menu toolbar.
2. Select **Encoding > V-stream Encoding**.
3. Check **Enable V-stream Encoding**.
4. Select the desired settings for frame rate, and maximum bit rate (Kbps).
Note: The maximum bit rate option is set to “General” only.
5. Click **Apply** to save the settings.

Chapter 10

Controlling a PTZ camera

You can control PTZ dome cameras using the buttons on the front panel, the keypad, and IR remote control as well as using the PTZ control panel accessed with the mouse. Access to PTZ commands may require a password.

A detailed list of the PTZ commands available for many different camera protocols is available in Appendix E on page 133.

Configuring PTZ settings

Use the **PTZ Settings** menu to configure the PTZ dome cameras. Each camera must be set up individually. Cameras must be configured before they can be used.

Ensure that the PTZ dome cameras are correctly connected to the RS-485 port on the back panel.

Note: If a camera does not work correctly after configuring the DVR, check the parameters entered.

To configure PTZ dome camera settings:

1. Click the **PTZ Control** icon on the quick access toolbar.

– Or –

Click the **PTZ Settings** icon in the menu toolbar.



2. Click **General** and select the PTZ dome camera to be configured from the drop-down camera list.
3. Select the baud rate, data bit, stop bit, parity, flow control, PTZ protocol and address for the camera. See Appendix F, “Default menu settings”, on page 133 for the default values.

Note: It is important to ensure that the settings correspond with those used in the PTZ camera.

4. Click **Copy** to copy the settings to another camera, if required.
5. Click **Apply** to save the settings.

Calling up presets, tours and shadow tours

When in live view you can quickly call up the list of existing presets, preset tours and shadow tours by using the front panel, remote control, mouse and keypad.

Front panel	Press the joystick to Enter. PTZ control panel appears.
Mouse	Right-click the mouse on the desired camera image. The quick access toolbar appears. Click the PTZ control icon to enter PTZ mode. The PTZ control panel appears.
Remote control	Press the OK button. The PTZ control panel appears.
Keypad	Press the Enter ↵ button on the keypad. For further information, see Appendix C “KTD-405 keypad” on page 123.

If the display was in multiview format, it changes to full-screen format for the selected camera. See Figure 21 below for a description of the PTZ control panel.

Figure 21: PTZ control panel

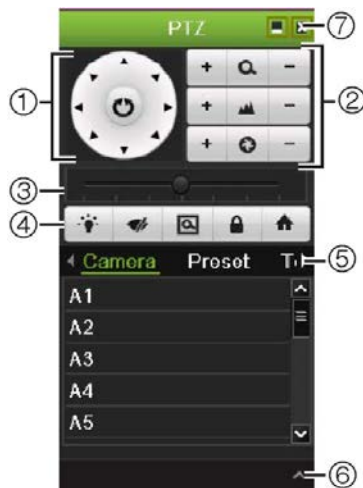





Table 15: Description of the PTZ control panel

Item	Name	Description
1.	Directional pad/auto-scan buttons	Controls the movements and directions of the PTZ. Center button is used to start auto-pan by the PTZ dome camera.
2.	Zoom, focus and iris	Adjusts zoom, focus and iris.
3.	PTZ movement	Adjusts the speed of PTZ movement.
4.	Toolbar	Turns on/off camera light.
		Turns on/off camera wiper.

Item	Name	Description
		 Zoom area.
		 Centers the PTZ dome camera image. This command is not supported on all PTZ dome cameras.
		 Jumps to the home position.
5.	Select PTZ command	Displays the desired function from the scroll bar: camera, preset, preset tour or shadow tour.
6.	Open/close menu	Opens/closes the PTZ command section of the PTZ control panel.
7.	Exit	Exits the PTZ control panel.

Setting and calling up presets

Presets are previously defined locations of a PTZ dome camera. It allows you to quickly move the PTZ dome camera to a desired position. They are configured and modified from the PTZ configuration window (see Figure 22 below).









Note: The PTZ dome camera used must be able to support a preset command. See Appendix E on page 133 for the complete list of PTZ commands available by camera protocol.

Figure 22: PTZ configuration window



Table 16: Description of the PTZ configuration window

Item	Name	Description
1.	Save preset	Saves preset.
2.	Call preset	Calls up pre-existing preset.
3.	Shadow tour toolbar	 Starts recording the shadow tour.

Item	Name	Description
		 Saves the shadow tour.
		 Starts the selected shadow tour.
		 Deletes the selected shadow tour.
4.	Preset tour toolbar	 Adds a step to a selected preset tour.
		 Starts the selected preset tour.
		 Stops the selected preset tour.
		 Deletes all the preset tour steps.
		 Scroll up the list.
		 Scroll down the list.

To set up a preset:

1. Click the **PTZ Settings** icon on the menu toolbar and select **More Settings**.
2. Use the directional, zoom, focus and iris buttons to position the camera in the desired preset location.
3. Check **Save Preset** and enter a preset number. The preset is enabled and stored in the camera.

If the desired preset number is larger than the 17 numbers listed, click [...]. The Preset window appears. Select a preset number from the dropdown list and click the **OK** button to save changes.

Note: Presets can be overwritten.

4. Click **Back** to return to live view.

To call up a preset:

- **PTZ control panel:**

1. In live view left-click the mouse and select the PTZ control icon in the quick access toolbar. The PTZ control panel appears. Select the desired camera from the toolbar.

– Or –

On the front panel, select the desired camera and press **Enter** on the joystick to call up the quick access toolbar. The PTZ control panel appears.

2. Scroll the toolbar to **Preset** and double-click the desired preset from the list. The camera immediately jumps to the preset position.

- **Menu toolbar:**

1. Click the **PTZ Settings** icon on the menu toolbar and select **More Settings**. The PTZ configuration window appears.
2. Check **Call Preset** and enter the preset number to call up. The camera immediately moves to that preset position.
3. Click **Back** to return to live view.

Setting and calling up preset tours

Preset tours move a PTZ dome camera to different steps (called “Keypoint” in the interface). The camera stays at a step for a set dwell time before moving on to the next step. The steps are defined by presets (see “Setting and calling up presets” on page 71.)

Each preset tour consists of steps. A step consists of a step number, a dwell time, and a speed.

The step number is the order the camera will follow while cycling through the preset tour. The dwell time is the length of time for which a camera stays at a step before moving to the next one. The speed is the rate at which the camera will move from one key point to the next.

Note: The PTZ dome camera used must be able to support a preset tour command. See Appendix E on page 133 for the complete list of PTZ commands available by camera protocol.

To set up a preset tour:

1. Click the **PTZ Settings** icon on the menu toolbar and select **More Settings**.
2. Select the preset tour number.
3. In the preset tour toolbar, click  to add a step to the preset tour. The Keypoint window appears. Select the preset number, dwell time and speed of the step. Click **OK** to save the settings.



Note: A preset tour should have at least two presets.

4. Repeat step 3 to configure other steps in the preset tour.



5. In the preset tour toolbar, click  to call up the preset tour.
6. Click **Back** to return to live view.

To delete a preset tour:

1. Click the **PTZ Settings** icon on the menu toolbar and select **More Settings**.
 2. From the preset list, select a tour number and click  to delete the selected the preset tour.
- Or –

In the preset tour toolbar, click  to delete all the preset tours.

3. Click **Back** to return to live view.

To call up a preset tour:



• **PTZ control panel:**

1. In live view left-click the mouse and select the PTZ control icon in the quick access toolbar. The PTZ control panel appears. Select the desired camera from the toolbar.
- Or –

On the front panel, select the desired camera and press **Enter** to call up the quick access toolbar. The PTZ control panel appears.

2. Scroll the toolbar to **Tour** and double-click the desired preset tour from the list. The camera immediately carries out the preset tour movement.

• **Menu toolbar:**



1. Click the **PTZ Settings** icon on the menu toolbar and select **More Settings**.
2. Select the desired preset tour from the list and click  to start the tour. Click  to stop the preset tour.
3. Click **Back** to return to live view.

Setting and calling up a shadow tour

The shadow tour command remembers the manually-controlled PTZ dome camera movement track. One shadow tour can be set up.

Note: The PTZ dome camera used must be able to support a shadow tour command. See Appendix E on page 133 for the complete list of PTZ commands available by camera protocol.

To set up a shadow tour:

1. Click the **PTZ Settings** icon on the menu toolbar and select **More Settings**.
2. Select the shadow tour from the list.
3. To record a new shadow tour, click  and use the directional buttons on the PTZ control panel to move the camera along the desired path.
4. Click  to save the shadow tour.

Note: The shadow tour can be overwritten.

5. Click **Back** to return to live view.

To call up a shadow tour:

- **PTZ control panel:**



1. In live view left-click the mouse and select the PTZ Control icon in the quick access toolbar. The PTZ control panel appears. Select the desired camera from the toolbar.

– Or –

On the front panel, select the desired camera and press **Enter** on the joystick to call up the quick access toolbar. The PTZ control panel appears.

2. Scroll the toolbar to **Shadow Tour** and double-click the shadow tour from the list. The camera immediately carries out the shadow tour movement.

- **Menu toolbar:**

1. Click the **PTZ Settings** icon on the menu toolbar and select **More Settings**.
2. Select the shadow tour from the list and click  to start the tour. Click  to stop the shadow tour.
3. Click **Back** to return to live view.

Chapter 11

Playing back a recording

The TVR 11 lets you to quickly locate and play back recorded video. There are four ways to play back video:

- Instant playback of the most recently recorded video
- All-day playback of the day's recorded video
- Search the video archives by specific time, date, snapshot or event
- Search the system log

The DVR continues to record the live view from a camera while simultaneously playing back video on that camera display. You must have the access privilege to play back recordings (see “Customizing a user’s access privileges” on page 106 for more information).

Cameras in multiview mode play back simultaneously. This means, for example, that it is easy to follow the path of an intruder who has passed in front of several cameras.

You must be in live view to play back video.

Overview of the playback window

It is easy to manage playback from the playback window.

The playback video has a time/date stamp on it for evidentiary purposes.

Figure 23: Playback window



1. Playback viewer.
2. Camera panel. Select the cameras for playback. Move the mouse over the area to display the list of cameras available.
3. Calendar panel.
Blue: Current date
Yellow: Recordings available on the DVR.
4. Playback control toolbar. See Figure 24.









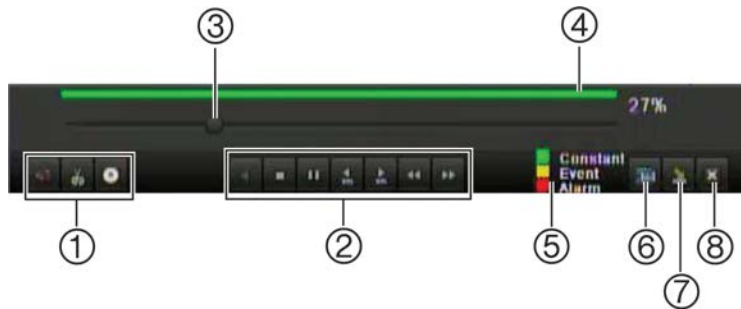

The playback control toolbar





It is easy to manually control playback using the playback control toolbar. See Figure 24 below.

Note: The control toolbar does not appear for instant playback.

Figure 24: Playback control toolbar (search playback example shown)



Item	Description
1.	Audio and video control toolbar:  /  Audio on/off.  /  Start/stop a video clip during playback. Sections of a recording can be saved to an external storage device.  Archive files
2.	Playback control toolbar:   Reverse play the recording. Click again to pause.  Stop playback. Timeline jumps back to 00:00 time (midnight).   Play recording. Click again to pause.

Item	Description
	Fast forward playback by 30 seconds.
	Reverse playback by 30 seconds.
	Decrease playback speed: Options available are: single frame, 1/8 speed, 1/4 speed, 1/2 speed, normal, X2 speed, X4 speed, X8 speed, maximum speed.
	Increase playback speed. Options available are: single frame, 1/8 speed, 1/4 speed, 1/2 speed, normal, X2 speed, X4 speed, X8 speed, maximum speed.
3.	<p>Timeline: Allows you to jump forwards or backwards in time. The timeline moves left (oldest video) to right (newest video). Click a location on it for where you want playback to start.</p> <p>In all-day playback the cursor shows the actual time. In search playback, the cursor is a ball.</p> <p>Time bar: Time of actual playback. This is only displayed in all-day playback.</p>
4.	<p>Playback progress bar: This bar displays how far playback of the recording has progressed. It also indicates the type of recording using color.</p>
5.	<p>Recording type: Description of the color coding of recording types that appear in the playback progress bar. Green indicates continuous recording. Red indicates alarm/event recording. Yellow indicates motion recording.</p>
6.	<p>Video search: This icon is only displayed when playback is the result of a search. It does not appear for all-day playback. Click it to return to the Search window and reselect the search criteria.</p>
7.	<p>Hide toolbar: Hide the playback control toolbar.</p>
8.	<p>Quit playback:</p> <p>For all-day playback mode, quit playback and return to live view.</p> <p>For playback from search mode, quit playback and return to the search results window.</p>

Instant playback



Use the quick access toolbar to quickly replay recorded video from the last five minutes. This can be useful to review an event that has just happened. Only one camera at a time can be selected. The default playback period of 5 minutes cannot be changed.

To instantly replay recorded video:

1. In live view left-click the mouse on the desired camera image. The quick access toolbar appears. Click **Instant Playback** .
2. Select the desired camera from the drop-down list and click **OK**.

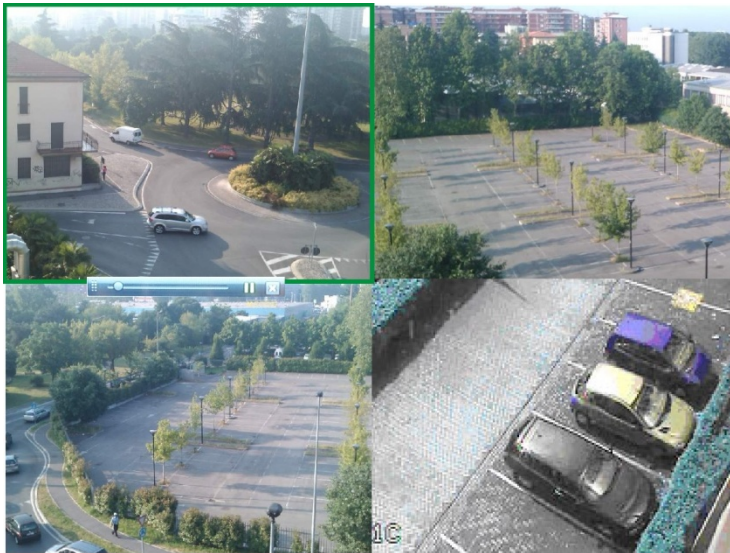
Playback starts immediately. The Instant Playback scroll bar appears under the selected camera.



3. Click **Pause**  on the toolbar to pause playback. Click **Play**  to restart playback. Click  to stop playback and return to live view.

All-day playback

Use this option to play back recorded video from the last day. Playback starts at midnight and runs for the 24-hour period. All-day playback is shown in full-screen view. See Figure 24 on page 78 for a description of the playback control toolbar.

To start all-day playback using the front panel:

1. In live view click the All-day playback button . Play back starts.

To start all-day playback using the mouse:

1. In live view right-click the mouse on the desired camera image. In the mouse toolbar that appears, click **All-day Playback**.

The playback window appears. By default, the camera is in full-screen mode.

2. To select more than one camera for multiview playback or to select playback from a different day, move the mouse to the right edge of the window. The camera list and calendar appear. Check the desired cameras and/or another day. Up to 16 cameras can be selected depending on the DVR model.

Playback starts immediately.

Note: A message appears if there are no recordings found during this period.

3. Use the playback control toolbar to manually control playback.

4. Click **Exit**  to return to live view.

– Or –

Right-click the mouse and click **Exit** from the mouse menu to return to the previous window.

Searching recorded video

You can easily search and play back recorded videos by camera, recording type, time period, events and snapshots.

The Search window has three submenus that allow you to carry out different searches by theme:

Search type	Description
Normal	Search all recorded video by cameras, recording type, type of file protection (locked or unlocked) and time period.
Event	Search only event recorded files. Files can be searched by alarm inputs, motion detection, or POS/ATM text insertion. Note: Only motion detection and POS/ATM text insertion that have been recorded as events will be listed in this search. Motion and text insertion that is recorded as a non-event can be searched under the Normal menu.
Picture	Search only recorded files with snapshots.

Search results

A search will usually produce a list of files, which may extend to several pages. The files are listed by camera, and then for each camera by date and time. The oldest file is listed first. See Figure 25 on page 82 for an example of the results from a search.

Only one file can be played back at a time.



Figure 25: Example of a search result list



Playing back recordings by time and video type

You can search recorded video by time and video type, such as continuous recordings, motion, text insertion, alarm and all recordings. Video can be played back simultaneously across several cameras.

To play back search results:

1. In live view mode right-click the mouse and in the mouse menu select **Advanced Search > Normal**.
2. Select the desired cameras, record type, file type as well as start and end time of the recording.
3. Click **Search**. The list of search results appears.
4. Play back the search results:
 - If there is only one camera in the search result, click its playback  button. Playback starts.
 - If there is more than one camera listed, click the playback  button of one of the cameras. In the window that appears, select the cameras you want to play back simultaneously and click **OK**. Playback starts.
5. To hide the playback control toolbar during play back, right-click the mouse and select the **Control Panel** button in the playback control toolbar. Click again for the panel to reappear.
6. Use the playback control toolbar to manually control playback.
7. To play back another camera, move the cursor to the right edge of the window to display the list of cameras and select the desired camera.

8. To do another search:

Click the **Event Search icon** in bottom right of the playback control toolbar or right-click the mouse and select **Event Search** from the list.

The search window reappears. Reselect the search criteria.

Playing back recordings by event

You can search recorded video by event type: alarm inputs, motion detection and POS/ATM text insertion. Video can be played back simultaneously across several cameras.

To play back search results by event:

1. In live view mode right-click the mouse and in the mouse menu select **Advanced Search > Event**.
2. Select the desired event type from the drop-down list (Alarm input, Motion or Text insertion) as well as the start and end time of the recording.
3. Select the desired alarm inputs.

If you selected “Motion” as the event type, select the required alarm inputs. If you selected “Text insertion”, select the required alarm inputs and enter the desired keywords.

4. Click **Search**. The list of search results appears.
5. Play back the search results:

If there is only one camera in the search result, click its playback  button. Playback starts.

If there is more than one camera listed, click the playback  button of one of the cameras. In the window that appears, select the cameras you want to play back simultaneously and click **OK**. Playback starts.

6. To hide the playback control toolbar during playback, right-click the mouse and select the **Control Panel** button in the playback control toolbar. Click again for the panel to reappear.
7. Use the playback control toolbar to manually control playback.
8. To play back another camera, move the cursor to the right edge of the window to display the list of cameras and select the desired camera.
9. To do another search:

Click the **Event Search icon** in bottom right of the playback control toolbar or right-click the mouse and select **Event Search** from the list.

The search window reappears. Reselect the search criteria.

Slideshow of snapshots

You can search captured snapshots and play them back in sequence as a slideshow. See “Accessing frequently used commands” on page 59 on how to create snapshots.

To play back search results:

1. In live view mode right-click the mouse and in the pop-up menu select **Advanced Search > Picture**.
2. Select the desired cameras as well as start and end time of the recording to be searched.
3. Click **Search**. The list of snapshots appears.
4. Select a snapshot to see it in the thumbnail window. Click its **Play**  button to see it in full-screen mode.
5. When in full-screen mode, move the cursor to the right edge of the window to see the complete list of snapshots found in the search. Click their Play buttons to see them in full-screen mode.
6. To see a slideshow of all the snapshots found, click the ► or ◀ buttons on the snapshot toolbar to sequence forwards or backwards through the shots.
7. To do another search:
Click the **Picture Search icon** in bottom right of the playback control toolbar or right-click the mouse and select **Picture Search** from the list.
The search window reappears. Reselect the search criteria.

Playing back recordings from the system log

You can also playback recordings from the system log. The system log provides a much wider range of options for playback than Advanced Search, which deals with video detection and alarms only.

You can search the recorded logs by:

- **Date and time.** Logs can be searched by date as well as start and end recording times.
- **Major record types.** There are five main types: All, Alarm, Notification, Operation and Information.
- **Minor record types.** The major record types can be searched by sub categories (minor record type). The selection of minor record types available depends on the major type selected. See Table 17 for the list.

Table 17: Main and minor record types

Major types	Minor types
All	All
Alarm	All, Alarm input, Alarm output, Start motion detection, Stop motion detection, Start tamper-proof, Stop tamper-proof
Notification	All, Video loss alarm, Abnormal video signal, Illegal login, HDD full, HDD error, IP conflicted, Network disconnected, Abnormal record, Input/output video standard mismatch
Operation	All, Power up, Local operation shutdown, Abnormal shutdown, Local operation restart, Local operation login, Local operation logout, Local operation configure parameters, Local operation upgrade, Local operation PTZ control
Information	All, Local HDD information, HDD S.M.A.R.T., Start recording, Stop recording, Delete expired record

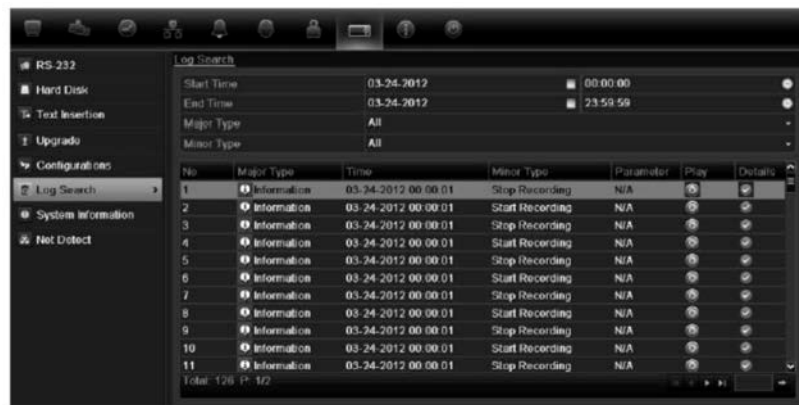
Figure 26: View log window

To play back video from the system log:

1. Click **System Settings > Log Search** in the menu toolbar.
2. Select the search start and end times.
3. Under **Major Type** and **Minor Type**, select an option from the drop-down list. The minor type list of options available depends on the option selected under major type.
4. Click the **Search** button. A list of results appears.
5. Select a file and click:
 - **Details:** Displays information on the log or recording. For a recording, it lists such information as start time, type of information, camera number, and gives a description on the types of events recorded and when record time was stopped.
 - **Play:** Click to start playback of the selected recording.
 - **Export:** Click to archive the selected file to a USB device. The export window appears.

- **Back:** Click to return to the previous window.

Motion search

You can quickly and easily search playback recording for incidents of motion detection. Motion can be searched over the whole playback window or just for specific areas on it. This allows you to search, for example, whether any motion was detected a few days ago near a particular door.

The option is not available in instant playback.

Figure 27: Motion search toolbar

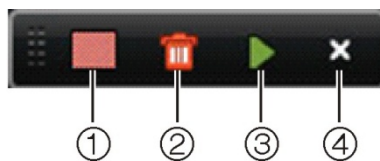

1. **Full screen detection:** The motion-sensitive red grid automatically appears over the whole window.
2. **Delete all:** Delete the motion grid.
3. **Search:** Search the playback recording for motion detection.
4. **Exit:** Quit motion search mode and return to play back.

To search for motion in playback:

1. In playback mode right-click the mouse and click **Motion Search** on the mouse menu. The motion search toolbar appears and the playback control toolbar disappears.
2. Select an area of the window to be searched:

Drag the mouse over the desired area. A red grid appears. More than one area can be selected.

- Or -

Click the full-screen detection icon in the toolbar. The whole window is covered in the red grid.

3. Click the **Search** icon in the toolbar to see the results.

Motion appears as blue lines below the green playback progress bar (see below). If motion had been recorded as an event, it appears as yellow on the progress bar.

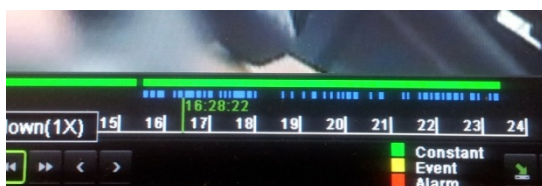

Click the **zoom-in** button to see the progress bar in closer detail.



Playing back frame-by-frame

You can easily play back a selected video at different speeds. This allows you to carefully examine an event frame-by-frame as it happens.

The current frame rate is shown on the right of the playback control toolbar.

To play back frame-by-frame:

• Using a mouse:

1. In playback mode click the **Speed Down**  and **Speed up**  buttons in the playback control toolbar until the speed changes to single frame.
2. Click the **Pause** button  to advance the video frame by frame.

• Using the front panel:

1. In playback mode press the up/down arrow buttons to scroll down and up through the speed changes until single frame.
2. Press **Enter** to advance the video frame by frame.
3. Press the **Playback** button  to continue playback at normal speed.

Digital zoom in playback

You can easily zoom in on an image during playback to see it in greater detail.

To digitally zoom-in during playback:

1. In playback mode right-click the mouse and click **Digital Zoom** in the pop-up menu. The playback control toolbar disappears.
2. Click the window with the cursor.
The image zooms in and the digital view window appears.
3. Left-click the mouse and drag the red square to the area of interest, or press the arrow buttons on the front panel to position the red square. The selected area is magnified. The size of the red square cannot be changed using the front panel.
4. Right-click the mouse to quit digital zoom and to return to full-screen playback mode. The playback control toolbar reappears.

Chapter 12

Archiving recorded files

Archive recorded files on an external device such as a USB flash drives, USB HDDs or a DVD writer. You must be in live view to archive video. Access to archive commands may require a password.

Before starting to archive files, ensure that you have the backup device connected to the DVR. It can be detected automatically by the DVR.

Note: The USB port on the rear panel does not support USB CD/DVD burners or USB HDDs.

Archiving files

There are two ways to archive files:

Quick Archive: Quick archive lets you archive recorded files quickly by using the Archive button on the front panel. The DVR then downloads all the recorded files on the unit to fill the available memory space on the media. This option is not available via the mouse.

Advanced Search window: Use the Export command in the Advanced Search window to specify archiving settings such as a specific time and date period as well as cameras.

Using Quick Archive

To archive recorded video using Quick Archive:

1. Insert the backup device into the TVR 11.

If using a USB memory drive, insert the device into the USB port on the front panel. If using a digital video disk (DVD), insert the disc into the DVD drive. If more than one media type is found, the USB device takes precedence over the others.

2. Press **Archive** on the front panel or remote control to open the quick archive window.
3. Click **Start**. The unit starts to download all the files listed.

Note: If there is a capacity limitation on the backup device, only the most recent files will be backed up.

A message will appear to confirm when the download is complete.

Exporting recorded files to a backup device

You can insert a mini-USB hub to the USB port to attach a mouse for navigation or a USB drive for archiving. However, the unit may not support all types of USB hubs.

The Archive options available may depend on the type of backup device selected.

Figure 28: Example of an export window

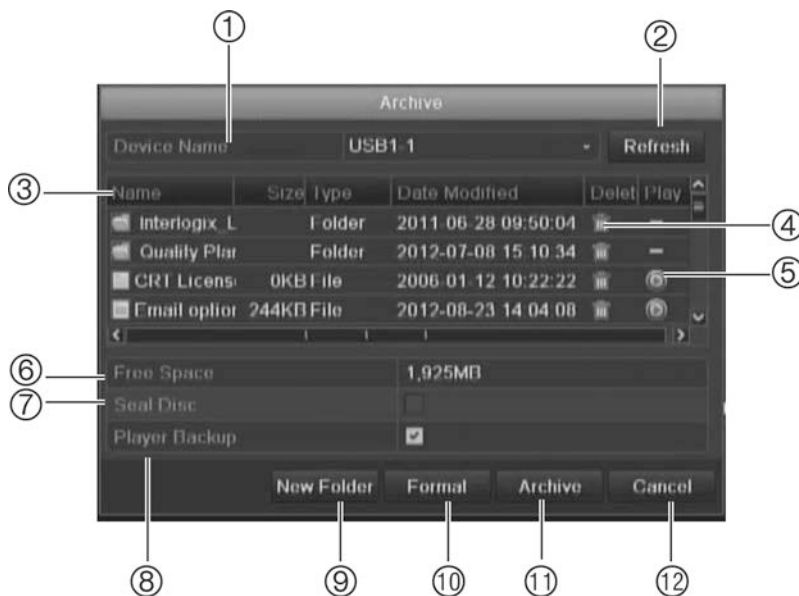

Item	Function	Description
1.	Device name	Select one of the storage media for archiving. If the backup device is not recognized: <ul style="list-style-type: none"> • Click the Refresh button • Reconnect device • Check for compatibility from vendor
2.	Refresh	Refresh the search results if any parameters have been modified.
3.	Name	Files found on the backup device are listed.
4.	Delete	Click to delete a selected file from the backup device.
5.	Play	Click to play selected file.
6.	Free space	Free space available on the backup device is displayed.
7.	Seal disc	Select to prevent other files being recorded onto the disc.
8.	Include Player	Select to automatically include the Player tool when archiving files.

Item	Function	Description
9.	New folder	Create a new folder on the backup device. Files from the DVR can be archived to a specific folder.
10.	Format	Format the USB/eSATA drive.
11.	Archive	Start downloading selected files onto the backup device.
12.	Cancel	Cancel search and return to previous menu.

To export recorded files to a backup device:

1. Connect the backup device to the DVR.

If using a USB memory drive, insert the device into the USB port on the front panel. If using a digital video disk (DVD) or eSATA drive, insert the disc into the DVD drive. If both media are found in the TVR 11, the USB device takes precedence over the DVD.

2. In live view mode press the **Search** button on the front panel or remote control.

- Or -

Right-click the mouse and select **Advanced Search**.

The Advanced Search window appears.

3. Select the cameras and search parameters required.
4. Click **Search**. The list of results appears.
5. Select the files to export.

Note: You can click the Play button to verify that the selected files are the files to export.

6. Click **Archive**. The Archive window appears.
7. Select the storage medium to export to from the drop-down list.
8. Click **Archive** to begin the backup process.

Creating and archiving video clips



You can save important scenes in a recorded file for later reference by creating video clips of selected portions of the file during playback. When an intruder, for example, crosses in front of several cameras you can save the video clip of the intruder's path across these cameras in a single file.

Up to 30 video clips can be made from a recording.

Note: This feature is only available using the mouse.

To export video clips during playback:

1. Connect the backup device to the DVR.

2. Search for the required files to play back. See “Searching recorded video” on page 81.
3. Select the file or files to play back and click **Play**. Playback starts immediately.
4. Click the playback timeline where you want the video clip to start and click the **Start Clip**  button.
5. Click the playback timeline where you want the video clip to stop and click the **End Clip**  button.
6. Repeat for additional clips.
7. Exit playback mode. A message appears asking if you want to save the video clips.
8. Click **Yes** to archive the clips. The Export window appears.
Click **No** to exit and return to the search results window. The clips are not saved.
9. In the Export window select from the drop-down list the backup device to be used.
10. Click **Start**. File downloading starts.
Note: You can create a new folder for the video clips. Press the **New Folder** button and enter the folder name.

Archiving snapshots

You can save all the video snapshots recorded to a backup device.

To archive snapshots:

1. Connect the backup device to the DVR.
2. Search for the required snapshot files to play back. See “Slideshow of snapshots” on page 84. The list of snapshots appears.
3. Select the snapshots to backup.
4. Click **Archive**. Select the archiving device, if different from that listed.
5. Click **Archive**. Export starts immediately.
6. When completed, click **OK**. Click **Cancel** to return to the previous window.

Managing backup devices

You can manage backup devices from the Export window (see Figure 28 on page 90.)

The Export window allows you to:

- **Create New Folder:** Create a new folder on the backup device.
- **Delete:** Delete a file or folder from the backup device.
- **Play:** Play the selected video file from the backup device.
- **Format:** Format the backup device.
- **Erase:** Erase files from a re-writable CD/DVD.

Playing back archived files on a PC

Use the standard file player software to play back the archived video on your PC. It is downloaded automatically from the TVR 11 when archiving files onto a backup device.

Chapter 13

DVR management

This chapter describes:

- Configuring the RS-232 port
- Updating system firmware
- Restoring default settings
- Viewing system information
- Viewing system logs

Configuring the RS-232 port

Use the System Settings menu to configure the RS-232 parameters such as baud rate, data bit, stop bit, parity, flow control, and usage.

Figure 29: RS-232 setup window



There are three ways the RS-232 port can be used:

- **ProBridge:** POS and ATM text insertion supported via the ProBridge accessory connected to the RS-232 port. See “Capturing text insertions” on page 116 for more information.
- **ATS/Challenger:** NTP time sync supported to foreign device over the RS-232 port.
- **Technical support:** Console mode.

Updating system firmware

The firmware on the DVR can be updated using four methods:

- Via an USB device
- Over the network via an FTP server
- Via the DVR web browser
- Using TruVision Navigator. For further information, refer to the TruVision Navigator user manual.

The firmware upgrade file is labeled *TVR11.dav*.

To update the system firmware using a USB device:

1. Download on to a USB the latest firmware from our web site at:
www.interlogix.com
- Or -
www.utcssecurityproductspages.eu/videoupgrades
2. Connect the USB device to the DVR.
3. Click the **System Settings** icon in the menu toolbar.
4. Select **Upgrade > Local Upgrade**. The list of files on the USB is displayed.



5. Select the file and click **Upgrade**. Click **Yes** to begin the upgrade process.
6. When the upgrade process is completed, reboot the DVR.

To update the system firmware via a FTP server:

For engineering purposes only.

Restoring default settings

To restore the default factory settings of the DVR:

1. Click the **System Settings** icon in the menu toolbar and select **Configuration**.
2. Click the **Default** tab. Click **OK** to confirm you want to restore default settings.

Note: Network information such as IP address, subnet mask, gateway, MTU, NIC working mode, server port, and default route are not restored to factory default settings.

Viewing system information

To view system information:

1. Click the **System Settings** icon in the menu toolbar and select **System Information**.
2. To view device information, click the **Device Info** tab.
3. To view camera information, click the **camera** tab.



4. To view record information, click the **Record** tab.



5. To view alarm information, click the **Alarm** tab.



6. To view network information, click the **Network** tab.



7. To view HDD information, click the **HDD** tab.

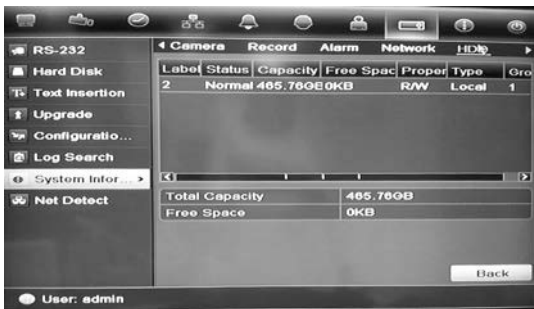

8. Click **Back** to return to live view.

Searching system logs for events

Many events of the DVR, such as operation, alarm and notification, are logged into the system logs. They can be viewed and exported at any time.

Up to 2000 log files can be viewed at once.



Log files can also be exported onto a USB device. The exported file is named according to the time it was exported. For example: *20120729124841logBack.txt*.

Note: Connect the backup device, such as a USB stick, to the DVR before commencing the log search.

To search and export log files:

1. Click the **System Settings** icon in the menu toolbar and select **Log search**.
2. Enter the search parameters and click **Search** to begin the search. The logs matching the search criteria are displayed.



3. To view more detail information about a particular log entry, select the entry and click  or double-click the log entry.
5. If available, you can also view the associated video to the selected log entry by clicking its play button .
5. To export a log entry, select a log and click **Export**.
4. Click **Back** to return to live view.

Chapter 14

Camera settings

The TVR 11 can support up to 16 analog cameras depending on the model.

Configuring the OSD settings

The DVR lets you configure which information is displayed on-screen for analog cameras only.

The on-screen display (OSD) settings appear in live view mode and include the camera name, time and date. They also are included in recordings.

You can also adjust the transparency of the OSD relative to the background so that it is easier to read or is less prominent on screen.

To configure the OSD settings:

1. Click the **Camera Management** settings icon in the menu toolbar and select **OSD**.



2. Enter a name for the camera, if required.
3. Check the Display Name, Display Date, and Display Week boxes to display the camera name, date, and week.
4. Select a date format and a time format.
5. Select how you want the camera information displayed.

Select one of the options from the drop-down list. Default is non-transparent/non-flashing.

- Transparent & flashing
 - Transparent & not flashing
 - Non-transparent & flashing
 - Non-transparent & non-flashing
6. There are two red text boxes in the camera view window; one for the camera name and the other for the date/time. Using the mouse, click and drag a text box to the desired position.
 7. To copy the settings to other cameras, click **Copy** and select the desired cameras. Click **OK**.
 8. Click **Apply** to save the settings and then **Back** to return to live view.

Setting up privacy masking

You can define an area on screen to remain hidden from view. For example, you can choose to block the view of a camera when overlooking residential premises. This hidden area is referred to as privacy masking. Privacy masking cannot be viewed in live view or recorded mode, and appears as a blank area on the video image.

To setup a privacy mask:

1. Click the **Camera Management** icon in the menu toolbar and select **Privacy mask**.
2. Select the camera for which to set up privacy masking.
3. Check the **Enable Privacy Mask** box to enable the feature.
4. Set up the mask area. Up to four areas can be set.

Using the mouse, click and drag a privacy-mask box in the camera view window over the desired area. You can set up to four areas for privacy masking. Masked areas are dimmed and outlined in four different colors. Click **Apply** to save settings.



To delete a mask, check the desired mask and click **Clear** for that color mask.

5. To copy the settings to other cameras, click **Copy** and select the desired cameras. Click **OK**.
6. Click **Apply** to save the settings and then click **Back** to return to live view.

Adjusting video image settings

You may need to adjust the camera image depending on the location background in order to get the best image quality.

The system has four preset mode settings for frequently encountered lighting conditions; Standard, Indoor, Low light and Outdoor. However, you can also manually adjust the brightness, saturation, contrast, and hue values using the Customize option. Adjustments to the settings affect both live view and recorded images.

Note: These options can also be modified from the image settings button on the live view quick access toolbar (see “Accessing frequently used commands” on page 59.)

To adjust display settings:

1. Click the **Camera Management** icon in the menu toolbar and select **Privacy mask**.
2. Select the camera for which to adjust the video image settings.
3. Select the desired mode value. Changes are seen immediately on screen.
If “Customize” is selected, adjust the brightness, saturation, contrast, and hue values by dragging each scroll bar.
4. Click **Apply** to save the settings and then click **Back** to return to live view.

Chapter 15

User management

By default the DVR comes with three user accounts: an Administrator account, an Operator account and a Guest account. These accounts provide multiple levels of access and functionality. See Table 18 below for a description of the different user accounts.

Table 18: User accounts

User	Description
Administrator	The administrator account includes extended menu with full access to all settings. The Administrator has the authority to add, delete or configure parameters for many of the system functions. There can only be one administrator. The user name is admin. The name cannot be modified. The default password is 1234.
Operator	The operator account includes reduced menu access to Video settings (inaccessible features are not visible). The default user name is "operator". The default password is 2222.
Guest	The guest account includes menu access with no programming possibilities (inaccessible features are not visible). The default user name is "guest". The default password is 3333.

Note: The default passwords should be changed for security reasons.

Adding a new user

Only a system administrator can create a user. You can add up to 16 new users. The access privileges of Operator and Guest users are predefined and cannot be modified

To add new users:

1. Click the **User Management** icon in the menu toolbar to display its window.
2. Click **Add** to enter the Add User window.
3. Enter the new user's name and password. Both the user name and password can have up to 16 alphanumeric characters.
4. Select the new user's access level: Operator or Guest.
5. Enter the user's MAC address to let the user access the DVR from a remote computer with this MAC address.
6. Click **Apply** to save the settings and **OK** to return to the previous window.
7. Define the user's permissions.

Click the Permission button  for the new user. In the Permissions pop-up window check the required access privileges for local, remote and camera configuration. See "Customizing a user's access privileges" below for the permission descriptions for each group.

Click **Apply** to save the settings and **OK** to return to the previous window.

8. Click **Back** to return to live view.

Customizing a user's access privileges

Only an administrator can allocate access privileges to Operator and Guest users. The access privileges can be customized for each user's needs. The administrator's access privileges cannot be changed.

There are three types of privilege settings: Local Configuration, Remote Configuration, and Camera Configuration.

Note: Only the administrator can restore factory default settings.

Local configuration settings

- **Local Log Search:** Search and view logs of the DVR.
- **Local Parameter Settings:** Configure parameters and restore factory defaults. You can also import/export the configuration from the DVR.
- **Local Advanced Operation:** Access HDD management (including the initialization and modification of disk properties). Update system firmware as well as stop the I/O alarm output.
- **Local Shutdown/Reboot:** Shutdown or reboot the DVR.

Remote configuration settings

- **Remote Log Search:** Remotely view logs that are saved on the DVR.
- **Remote Parameter Settings:** Remotely configure parameters, restore factory defaults parameters and import/export configuration.
- **Remote Camera Management:** Remotely enable and disable channels.
- **Remote Serial Port Control:** Configure settings for the RS-232 port.
- **Remote Video Output Control:** Configure settings for video output.
- **Two-Way Audio:** Use two-way audio between the remote client and the DVR.
- **Remote Alarm Control:** Remotely alert or control the relay output of the DVR. Alarm and notification settings must be configured properly to upload to host.
- **Remote Advanced Operation:** Remotely manage HDDs (initializing and setting properties for HDDs) as well as remotely update system firmware and clear the I/O alarm output.
- **Remote Shutdown/Reboot:** Remotely shutdown or reboot the DVR.

Camera configuration settings

By default, all analog cameras are enabled for operators for each of these settings and none for guests.

- **Remote Live View:** Select and view live video over the network.
- **Local Manual Operation:** Locally start/stop manual recording on any of the channels, snapshots and video clips.
- **Local Playback:** Locally play recorded files that are on the DVR.
- **Remote Playback:** Remotely play and download recorded files that are on the DVR.
- **Remote PTZ Control:** Remotely control PTZ dome cameras.
- **Local Backup:** Locally back up recorded files from any of the channels.

To customize a user's access privileges:

1. Click the **User Management** icon in the menu toolbar to display its window.
2. Click the Permission button  for the user whose access privileges need to be changed. The Permissions pop-up window appears.
3. Click **Apply** to save the settings.
4. Click the **OK** button to return to the previous window.
8. Click **Back** to return to live view.

Deleting a user

Only a system administrator can delete a user.

To delete a user from the DVR:

1. Click the **User Management** icon in the menu toolbar to display its window.
2. Click the **Delete** button  for the user to be deleted.
3. Click **Yes** in the pop-up window to confirm deletion. The user is immediately deleted.
4. Click **Back** to return to live view.

Modifying a user

A user's name, password, access level and MAC address can be changed. Only a system administrator can modify a user.

To modify a user:

1. Click the **User Management** icon in the menu toolbar to display its window.
2. Click the **Edit** button  for the user whose access privileges need to be changed. The Edit User pop-up window appears.
3. Edit the user information and click **Apply** to save the settings. .
4. Click the **OK** button to return to the previous window.
5. Click **Back** to return to live view.

Changing the Admin password

The administrator's password can be changed in the **User Management** menu. Click the **Change Password** tab and enter the new information. The administrator's MAC address can be changed here too. Once completed, click **Apply** to save the settings.

Chapter 16

Using the web browser

This chapter describes how you can use the web browser interface to configure the device, play back recorded video, search through event logs, and control a PTZ dome camera. You can also specify settings on the web browser interface to optimize video playback and recording performance when operating in a low or limited bandwidth environment. Many of the browser configurations are similar to those done locally.

Windows Vista and 7 users

Internet Explorer for Windows Vista and Windows 7 operating systems have increased security measures to protect your PC from any malicious software being installed. When using the TVR 11 web browser interface, you can install ActiveX controls to connect and view video using Internet Explorer.

To have complete functionality of the web browser interface and the DVR player with Windows Vista and Windows 7, do the following:

- Run the Browser interface and the DVR player application as an administrator in your workstation
- Add the DVR's IP address to your browser's list of trusted sites

To add the DVR's IP address to Internet Explorer's list of trusted sites:

1. Open Internet Explorer.
2. Click **Tools**, and then **Internet Options**.
3. Click the Security tab, and then select the Trusted Sites icon.
4. Click **Sites**.
5. Clear the "Require server verification (https:) for all sites in this zone" box.
6. Enter the IP address or DDNS name in the "Add this website to the zone" field.
7. Click **Add**, and then click **Close**.
8. Click **OK** in the Internet Options dialog box.

9. Connect to the TVR 11 for full browser functionality.

Accessing the web browser

To access the TVR 11, open the Microsoft Internet Explorer web browser and enter the IP address assigned to the TVR 11, as a web address. On the logon window, enter the default user ID and password.

Note: Only one DVR can be viewed per browser.

User ID: admin

Password: 1234

The default values for TVR 11 network settings are:

- IP address - 192.168.1.82
- Subnet mask - 255.255.255.0
- Gateway address - 192.168.1.1
- Server Port: 8000
- HTTP Port: 80







Web browser overview





The TVR 11 web browser lets you view, record, and play back videos as well as manage all aspects of the DVR from any PC with Internet access. The browser's easy-to-use controls give you quick access to all TVR 11 functions. See Figure 30 below.

Figure 30: Live view in the web browser interface



Table 19: Description of live view in the web browser

Item	Name	Description
1.	Camera	Select the camera.
2.	Menu toolbar	Lets you do the following: <ul style="list-style-type: none"> • View live video • Play back video • Search for event logs • Configure settings • Log out of the interface
3.	Viewer	View live or playback video.
4.	Display format	Define how you want video to be displayed in the viewer: Multiview or full-screen.
5.	Video function toolbar	Lets you do the following in live view: <ul style="list-style-type: none">  Switch between mainstream and substream.  Start/stop all streaming from selected cameras.  Start recording from selected cameras.  Digital zoom.  Turn POS/ATM text insertion on/off.  Take a video snapshot.

Item	Name	Description
		 View previous and next camera respectively.
		 If viewing in multiview format, live view moves to the next group of cameras for the selected number of video tiles.
		 Turn audio on/off
		 Turn microphone on/off
6.	PTZ panel	Hide/display the PTZ panel.

Using the web browser to configure the device

Click **Config** on the menu bar to display the configuration window. There are two ways to configure the DVR: Local and Remote.

Local configuration

Local configuration lets you define communication and network parameters such as protocol type, maximum file size, stream type and network transmission settings. You can also specify the directory locations for saving recorded and playback video, captured images, and downloaded files.

Remote configuration

Remote configuration lets you remotely configure the following DVR settings:

- DVR information including device name, number, and overwrite option as well as time and holiday settings.
- Camera settings including motion detection, privacy masking, video loss, video tampering, video image display settings, and text overlay
- Recording settings including recording schedule and recording quality
- Network settings including, e-mail, DDNS, and NTP setup
- Serial port settings including RS-485 and RS-232 parameters
- Alarm settings including alert notifications, audio alerts, pre-alarm, and post-alarm seconds, and notification parameters
- System settings including, user management, date and time, audio, RS-485, RS-232, language, alarm notification, and hard drive setup

See Figure 31 below. Please refer to the specific chapters on this manual for detailed information on configuring the different functions.

Note: The configuration settings defined remotely are different from those that can be defined locally.

Figure 31: Remote browser configuration window (Display Settings window shown)

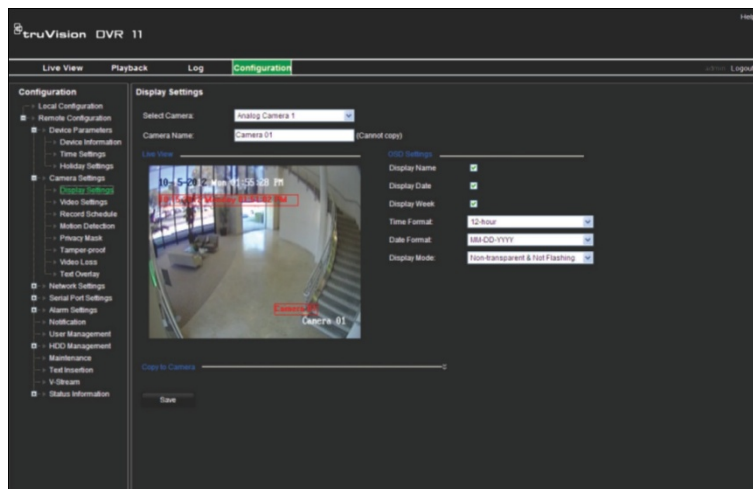













Searching and playing back recorded video

To search and play back recorded video, click Playback on the menu bar to display the Playback page shown in Figure 32 below.

Figure 32: Browser playback page



Item	Description
1.	Selected camera.
2.	Calendar: Selected day is highlighted.
3.	Search: Click to start searching recorded files for the selected camera.
4.	Display format: Click to change the display format: single view or multiview display.

Item	Description
5.	Timeline: The timeline moves left (oldest video) to right (newest video). Click a location on the timeline to move the cursor to where you want playback to start.
6.	Playback control toolbar:
	 Reverse: Click to reverse playback.
	 Start/stop: Start or stop playback.
	 Stop playback. Timeline jumps back to 00:00:00 time (midnight) of the previous day.
	 Playback slow forward: Click to scroll through the different speeds available: single frame, 1/8 speed, 1/4 speed, 1/2 speed, normal, X2 speed, X4 speed, X8 speed, maximum speed. Current speed is displayed under the camera name on top right of window.
	 Playback fast forward: Click to scroll through the different speeds available: single frame, 1/8 speed, 1/4 speed, 1/2 speed, normal, X2 speed, X4 speed, X8 speed, maximum speed. Current speed is displayed under the camera name on top right of window.
	 Single frame: Click to play back one frame at a time.
7.	 Stop streaming: Stop streaming from all cameras.
8.	Audio and video control toolbar:
	 Text insertion: Click to enable/disable POS/ATM text display in playback.
	 Snapshot: Capture a snapshot of the video.
	 Video clips: Start/stop video clip during playback. Sections of a recording can be saved to an external storage device.
	 Download: Download video clips.
	 Backup: Click to make back up of recorded files to save locally on the DVR. A list of the recorded files appears
	 Audio: Click to enable/disable audio.
9.	Type of recording: Green: Indicates video recorded based on the recording schedule defined. Red: Indicates video recorded triggered by an alarm event. Yellow: Indicates video recorded triggered by motion detection. Blue: Indicates video recorded triggered by a POS/ATM text recording.
10.	Jump start: Enter a precise time in the box and click the Go To button to jump start the playback at this selected time.

Select a camera and a day to search from on the calendar displayed, and then click Search. The timeline below the page indicates video recorded for the specified day. The timeline also classifies by color the type of recording with each type.

Click and drag the marker across the timeline on where you want video playback to begin, and then click Play on the playback control toolbar. You can capture a snapshot of a video image, save the video playback, or download the recorded video.

Searching for event logs

The DVR compiles a log of events, such as the start or end of video recording, DVR notifications, and alarms, through which you can easily search. Logs are categorized by the following types:

- **Alarm:** Includes motion detection, tamper detection, video tampering, and other alarm events
- **Notifications:** Includes system notifications such as video loss, HDD failures, and other system-related events
- **Operations:** Includes users access to the web interfaces and other operational events
- **Information:** Includes general information on the DVR actions, such as the start and end of video recording, etc.

To search for logs, click Log on the menu bar, select a log type, specify a date and time range, and then click Search.

Controlling a PTZ dome camera in the web browser

The web browser interface lets you control the PTZ functions of a dome camera. Click a PTZ dome camera and use the PTZ controls on the interface to control the PTZ functions.

Figure 33: PTZ controls

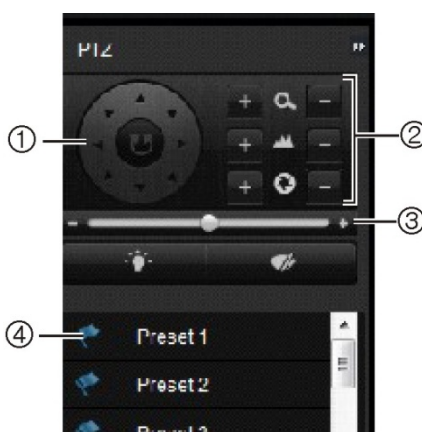

1. Directional pad/auto-scan buttons: Controls the movement and direction of the PTZ camera. Center button is used to start auto-pan by the PTZ dome camera.
2. Adjusts the zoom, focus, and iris functions.
3. Adjusts the speed of PTZ dome camera.
4. Starts the selected preset.

Capturing text insertions

The TVR 11 supports Point-of-Sale (POS) and ATM text insertion via the UTC ProBridge accessory connected to the RS-232 port on the DVR. This feature is currently only available using the browser.

See Figure 34 below for an example of a video image in live view with text insertion.

Figure 34: Example of a video image with text insertion



To set up text insertion:

1. Click the **Configuration** tab in the browser toolbar and then select **232 Serial Port**.



2. Under **Usage**, select ProBridge.
3. Select **Text Insertion**.

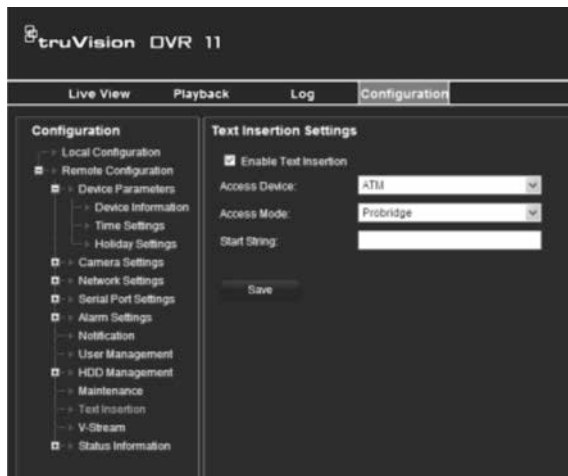

4. Check **Enable text insertion**.
5. Select the access device from the drop-down list.
6. Select the access mode. Only “ProBridge” is listed.
7. Under “Start String”, enter the desired transaction text such as an ATM transaction number.
8. Click **Apply** to save the settings.

Appendix A

Specifications

	TVR 1104	TVR 1108	TVR 1116
Video & audio input			
Video compression	H.264		
Analog video input	4-ch, BNC (1.0 Vp-p, 75 Ω), PAL /NTSC self- adaptive	8-ch, BNC (1.0 Vp-p, 75 Ω), PAL /NTSC self- adaptive	16-ch, BNC (1.0 Vp-p, 75 Ω), PAL /NTSC self- adaptive
Audio compression	G711		G722
Audio input	4-ch, RCA (2.0 Vp-p, 1 kΩ)		
Two-way audio	1-ch (reduplicated with audio input 1), RCA (2.0 Vp-p, 1 kΩ)		
Video & audio output			
HDMI output	1-ch, Resolution: 1920 × 1080P / 60 Hz, 1600 × 1200 / 60 Hz, 1280 × 1024 / 60 Hz, 1280 × 720 / 60 Hz, 1024 × 768 / 60 Hz		
VGA output	1-ch, Resolution: 1920 × 1080P / 60 Hz, 1600 × 1200 / 60 Hz, 1280 × 1024 / 60 Hz, 1280 × 720 / 60 Hz, 1024 × 768 / 60 Hz		
CVBS output	1-ch, BNC (1.0 Vp-p, 75 Ω), Resolution: PAL: 704 × 576; NTSC: 704 × 480		
Video loop output	4-ch	8-ch	16-ch
Encoding resolution	4CIF / 2CIF / CIF / QCIF		
Frame rate	8 fps at 4 CIF, 15 fps at 2CIF, 25 fps (PAL) / 30 fps (NTSC) at CIF/QCIF Total frame rate: 120 fps		
Video bit rate	32 to 4096 Kbps, or user defined (max. 3072 Kbps)		
Audio output	1-ch, RCA		
Audio bit rate	64 Kbps		
Dual-stream	Support (Sub-stream at CIF: 6 fps, QCIF: 25 fps (PAL) / 30 fps (NTSC))		
Stream type	Video, Video & Audio		

	TVR 1104	TVR 1108	TVR 1116
Playback resolution	4CIF / 2CIF / CIF / QCIF		
Synchronous playback	4-ch	8-ch	16-ch
Hard disk			
SATA	2 SATA interfaces		
Capacity	Models without CD/DVD burner: 2 HDDs. Up to 4TB capacity for each disk Models with CD/DVD burner: 1 HDD. Up to 2TB capacity		
External interface			
Network interface	1 RJ45 10M / 100M Ethernet interface		
Serial interface	1 RS-232 interface (for ProBridge, Challenger, Technical Support); 1 RS-485 interface (for PTZ control or KTD405 keyboard control)		
USB interface	2, USB 2.0		
Alarm in	4		
Alarm out	1		
Miscellaneous			
Power supply	12 VDC		
Power consumption (without HDD or DVD-R/W)	≤ 15 W	≤ 20 W	≤ 30 W
Operating temperature	-10 to +55 °C (14 to 131 °F)		
Relative humidity	10 to 90%		
Chassis	1.5U chassis		
Dimensions (W x H x D)	362 x 330 x 78 mm (14.25 x 13.0 x 3.07 in.)		
Weight	≤ 3 kg (6.6 lb.) (without HDD or DVD-R/W)		

Appendix B

PTZ protocols

Interlogix-485	PHILIPS
Interlogix-422	PHILIPS-3
Kalatel	SAE
DSCP	Samsung
HIKVISION	Siemens
Honeywell	SONY-EVI-D30/31
INFINOVA	SONY-EVI-D70
KTD-348	SONY-EVI-D100/P
LG MULTIX	TECHWIN
LILIN	VICON
PANASONIC_CS850	YOULI
PELCO-D	
PELCO-P	

Appendix C

KTD-405 keypad

Supported firmware

TVR 11XX-XXX firmware	1.0i or higher
KTD-405U (-2DU) keypad firmware:	1.4.00

Note: XXX is represents the DVR storage configuration such as 1T = 1 TB, etc.

Wiring the keypad

Connect the RS-485 bus of the KTD-405 I/O box to the RS-485 port of the TVR 11.

Table 20: Keypad and DVR connections

KTD-405 I/O box	TVR 11 connection
RS-485 A	D+
RS-485 B	D-

Figure 35: Keypad and DVR connections

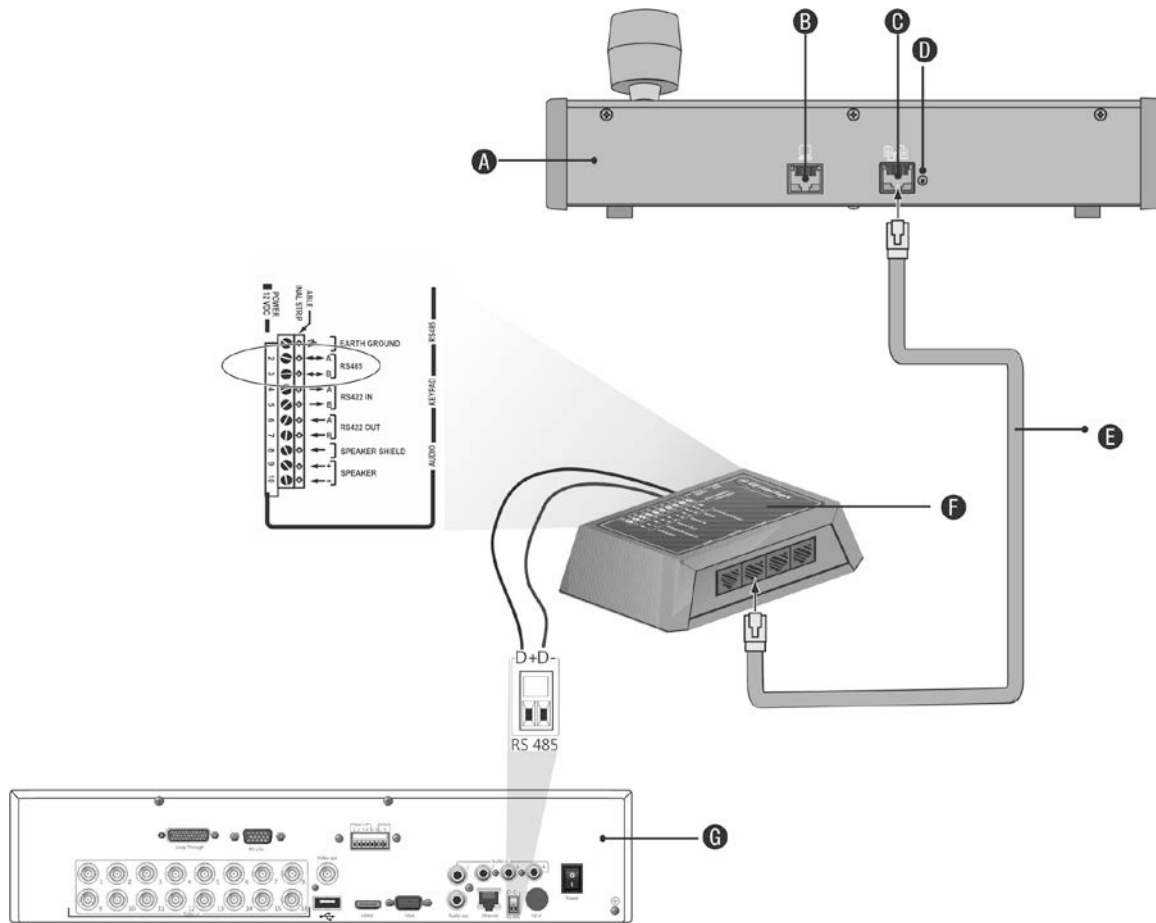

- A. KTD-405 keypad
- B. RS-232 programming port
- C. RS-485 and RS-422 in/out
- D. RS-485 termination switch
- E. RJ45 cable control (use the cable provided with the equipment)
- F. I/O box
- G. TVR 11 back panel

See “Connecting a KTD-405 keypad and dome camera to the TVR 11” on page 11 for information on how to connect both a keypad and dome camera to the TVR 11.

Setting up the keypad to work with the TVR 11

The keypad must be in zone mode to connect correctly with the TVR 11.

Further information on connecting and programming the KTD-405 keypad can be found in the user manual.

To set the keypad in zone mode:

1. Log into the keypad using the Admin password. Hold down the Enter button (↵) until a beep sounds and then enter the following code: 1 4 7 6. Push the **seq** button to confirm.
2. Scroll through the menus with the **▶** button until this menu appears:

```
OPERATING MODE:
DIGIPLEX
```

3. Change *Operating Mode* to *Zone* by moving the joystick down.
4. Quit the menu by pressing the **seq** button. The display will show, for example:

```
ZONE --ZONE TITLE
CAMERA --MONITOR
```

5. To connect it to the DVR, press the **zone** button and enter the ID number of the TVR 11. The default value is "1".
6. To configure the DVR zone ID number, at the DVR enter the System View window by selecting **System** in the main menu. Under Zone ID, enter the zone ID value. The default value is "1".

Note: The zone ID value must be identical for the DVR and keypad.

The TVR 11 is now connected to the KTD-405 keypad.

To configure the TVR 11 device address:

1. Click the **Display Mode Settings** icon in the menu toolbar and select **Monitor**.
2. Under the Device address edit box enter a numeric value. The default address for the keypad is "255". Click **Apply**

TVR 11 and keypad functions

The KTD-405U acts as a DVR control keypad when connected to the TVR 11. The keypad mimics many of the functions available from the front panel of the TVR 11.

Unavailable TVR 11 functions

The following TVR 11 functions are unavailable when using the keypad to control the TVR 11:

- Export video
- Eject CD/DVD
- Preset and shadow tour
- Select motion detection or tampering zones

- Archive records
- Capture video

If these functions are required, it is recommended to use a mouse in conjunction with the keypad as all TVR 11 functions will then be available.

Unavailable keypad functions

The following keypad buttons are unavailable when using the keypad to control the TVR 11:

Figure 36: Keypad buttons unavailable

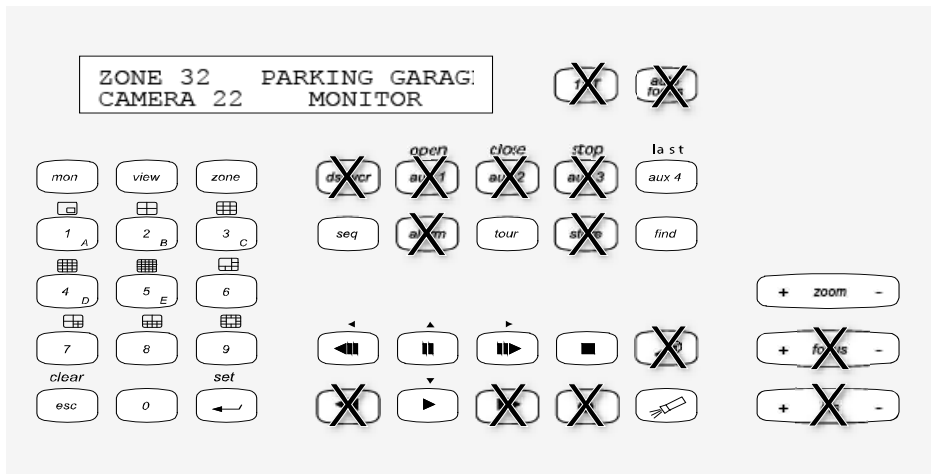

DSC/VCR	Autofocus	● (Record mode)
Aux 1	Alarm	Store
Aux 2	Iris +/-	▶▶ Fast forward
Aux 3	Focus +/-	◀◀ Fast backward
Ist	🔍 (Magnification)	

Operating the keypad

You can navigate the TVR 11 menus using the keypad buttons and joystick. However, not all maneuvers are available using the joystick.

See Table 21 on page 128 for the description of the DVR keypad mapping when using the KTD-405 keypad series. See Figure 36 above for a list of the keypad functions that are unavailable when connected to the TVR 11

Example 1: To enter your password in the login window using the keypad

1. In live view mode, press **esc** to activate the Login window.
2. Press and hold **esc** and then press the arrow buttons (⏵ **down**, ⏶ **up**, ⏴ **left**, ⏴ **right**) to move the cursor to the Password edit box. Once in the password box, release **esc**.

3. Press **Enter** (↵) to activate the soft keyboard.
4. Press and hold **esc** and then press the arrow buttons to reach the first digit of the password. Release **esc** and press **Enter** (↵) to select the digit.
Or move the joystick to the first digit of the password and press **Enter** (↵).
5. Repeat steps 2 to 4 for each digit of the password.
6. Move the cursor to the Enter button on the soft keyboard and press **Enter** (↵) on the KTD-405 keypad to quit the soft keyboard.
7. Press and hold **esc** and then press the arrow buttons to navigate the cursor to activate OK button on the Login window.
8. Press ↵. The main menu appears.









Example 2: To modify a menu option using the keypad







1. In the main menu press and hold **esc** and then press the arrow buttons to navigate to the desired menu icon (for example, Display Mode Settings).
2. Press **esc** and  to go to setup menu.
3. Press **seq** to scroll to the menu tab, More Settings.
4. When in the desired menu window, press and hold **esc** and then press the arrow buttons to navigate the cursor to the option, **Menu Timeout**.
5. Press ↵ to activate the dropdown menu.
6. Press and hold **esc** and then press the up/down arrow buttons to navigate to the desired option.
7. Press ↵ to select the option.
8. Press and hold **esc** and then press the up/down arrow buttons to navigate to **Apply**. Press ↵ to select it. Then navigate to **Back** to return to live view.

Instead of the arrow buttons, you can also use the joystick on the keyboard.

TVR 11 mapping to the KTD-405 keypad

Table 21: TVR 11 mapping to the KTD-405 keypad

Task	Keypad action	Further information
• Menu mode		
Call up or exit menu	In live view, press esc .	To exit the menu: Go to the Power Manager menu and select Logout.
Move through the menus	Press and hold esc and then press the arrow buttons.	 Down ,  Up ,  Left ,  Right
Move between menu tabs	Press seq to switch between menu tabs.	
Navigate to a menu option	Press and hold esc and then press the arrow buttons. Or move the joystick.	 Down ,  Up ,  Left ,  Right
Select a character or menu option	Press Enter (↵).	Note. If you press esc before pressing Enter , you quit the menu without saving any changes. It is the same as Cancel.
Select the zone ID	Press zone to connect the keypad to the DVR.	
• Live view mode		
Call up a single camera	Press 0 to 9 and then press Enter (↵).	Using the numeric buttons 0 to 9 , enter the number of the camera and then press Enter (↵).
Call up multiview windows	Press view and then press button 5 to scroll through the next available multiview screen.	
Sequence through cameras	Press the seq button to scroll through the cameras in full screen.	
Sequence through multiview windows	Move the joystick to the right (= next camera), or the left (=previous camera).	
Switch between monitor A and monitor B	Press the mon button and button 1 to switch to monitor A. Press the mon button and button 2 to switch to monitor B.	
Manually acknowledge an alarm	Press Alarm .	

Task	Keypad action	Further information
• PTZ functions		
Enter PTZ mode	In live view mode, press Enter (↵).	It is possible that you first need to login before you can access the PTZ mode.
PTZ functions (Up, Down, Left, Right, Zoom in, Zoom out)	Move the joystick to move the dome up, down, left and right Press zoom+ and zoom- .	KTD-405U : Turn the knob on the joystick to zoom in/zoom out. KTD-405-2DU : Press the zoom+ and zoom- buttons.
Leave PTZ mode	Press esc .	
• Playback functions		
Search for recorded video	Press  .	Once password is entered, the Advanced Search menu appears.
All-day playback	Press  when in full screen.	All-day playback of the currently selected camera.
Stop playback	Press  to stop playback and return to live view mode.	
Pause playback	Press  to pause playback. Press  to restart.	
Select one of the files in the search result screen	Press enter (↵) and move the joystick to the desired file. Press  to start playback.	
Change playback speed	Press and hold esc and then press the left/right arrow buttons	
Jump 30 seconds forwards or backwards during playback	Press and hold esc and then press the up/down arrow buttons	

Controlling a camera

When setting up and controlling your cameras in zone mode, refer to Table 22 on page 130 for the list of default PTZ addresses associated with a zone ID. This value is automatically populated in the system. You can modify the PTZ address in the PTZ menu to meet customer requirements (see “Configuring PTZ settings” on page 69).

Table 22: Default PTZ camera addresses by zone ID

Camera input	Zone ID of TVR 11															
	1	2	3	4	5	6	7	8	9	10	11	12	13	14	15	16
1	0	32	64	96	128	160	192	224	256	288	320	352	384	416	448	480
2	1	33	65	97	129	161	193	225	257	289	321	353	385	417	449	481
3	2	34	66	98	130	162	194	226	258	290	322	354	386	418	450	482
4	3	35	67	99	131	163	195	227	259	291	323	355	387	419	451	483
5	4	36	68	100	132	164	196	228	260	292	324	356	388	420	452	484
6	5	37	69	101	133	165	197	229	261	293	325	357	389	421	453	485
7	6	38	70	102	134	166	198	230	262	294	326	358	390	422	454	486
8	7	39	71	103	135	167	199	231	263	295	327	359	391	423	455	487
9	8	40	72	104	136	168	200	232	264	296	328	360	392	424	456	488
10	9	41	73	105	137	169	201	233	265	297	329	361	393	425	457	489
11	10	42	74	106	138	170	202	234	266	298	330	362	394	426	458	490
12	11	43	75	107	139	171	203	235	267	299	331	363	395	427	459	491
13	12	44	76	108	140	172	204	236	268	300	332	364	396	428	460	492
14	13	45	77	109	141	173	205	237	269	301	333	365	397	429	461	493
15	14	46	78	110	142	174	206	238	270	302	334	366	398	430	462	494
16	15	447	79	111	143	175	207	239	271	303	335	367	399	431	463	495
17	16	48	80	112	144	176	208	240	272	304	336	368	400	432	464	496
18	17	49	81	113	145	177	209	241	273	305	337	369	401	433	465	497
19	18	50	82	114	146	178	210	242	274	306	338	370	402	434	466	498
20	19	51	83	115	147	179	211	243	275	307	339	371	403	435	467	499
21	20	52	84	116	148	180	212	244	276	308	340	372	404	436	468	500
22	21	53	85	117	149	181	213	245	277	309	341	373	405	437	469	501
23	22	54	86	118	150	182	214	246	278	310	342	374	406	438	470	502
24	23	55	87	119	151	183	215	247	279	311	343	375	407	439	471	503
25	24	56	88	120	152	184	216	248	280	312	344	376	408	440	472	504
26	25	57	89	121	153	185	217	249	281	313	345	377	409	441	473	505
27	26	58	90	122	154	186	218	250	282	314	346	378	410	442	474	506
28	27	59	91	123	155	187	219	251	283	315	347	379	411	443	475	507
29	28	60	92	124	156	188	220	252	284	316	348	380	412	444	476	508
30	29	61	93	125	157	189	221	253	285	317	349	381	413	445	477	509
31	30	62	94	126	158	190	222	254	286	318	350	382	414	446	478	510
32	31	63	95	127	159	191	223	255	287	319	351	383	415	447	479	511

Appendix D

Maximum pre-recording times

The maximum pre-recording time that can be selected depends on the bit rate. Frame rate, resolution and image quality do not impact time.

Note: This information only applies when the bit rate is set to Constant (see “Initializing the recording settings” on page 17 for more information).

Constant bit rate	Maximum pre-recording time (seconds)
32	30
48	30
64	30
80	30
96	30
128	30
160	30
192	30
224	30
256	30
320	30
384	30
448	30
512	30
640	30
768	30
896	30
1024	30
1280	25
1536	20

Constant bit rate	Maximum pre-recording time (seconds)
1792	15
2048	15
3072	10
4096	5

Appendix E

Supported PTZ commands

Table 23: Supported PTZ commands by camera protocols (Part 1)

Protocol	PTZ command												
	Tilt up	Tilt down	Pan left	Pan right	Left up	Left down	Right up	Right down	Auto pan	Zoom +	Zoom -	Focus +	Focus -
Interlogix-485	Y	Y	Y	Y	N	N	N	N	N	Y	Y	Y	Y
Interlogix-422	Y	Y	Y	Y	N	N	N	N	N	Y	Y	Y	Y
KALATEL	Y	Y	Y	Y	N	N	N	N	N	Y	Y	Y	Y
DSCP	Y	Y	Y	Y	N	N	N	N	N	Y	Y	Y	Y
HIKVISION	Y	Y	Y	Y	Y	Y	Y	Y	Y	Y	Y	Y	Y
Honeywell	Y	Y	Y	Y	N	N	N	N	N	Y	Y	Y	Y
INFINOVA	Y	Y	Y	Y	N	N	N	N	N	Y	Y	Y	Y
KTD-348	Y	Y	Y	Y	N	N	N	N	N	Y	Y	Y	Y
LG MULTIX	Y	Y	Y	Y	N	N	N	N	N	Y	Y	Y	Y
LILIN	Y	Y	Y	Y	N	N	N	N	N	Y	Y	Y	Y
PANASONIC_CS850	Y	Y	Y	Y	N	N	N	N	N	Y	Y	Y	Y
PELCO-D	Y	Y	Y	Y	Y*	Y*	Y*	Y*	Y	Y	Y	Y	Y
PELCO-P	Y	Y	Y	Y	Y*	Y*	Y*	Y*	Y	Y	Y	Y	Y
PHILIPS	Y	Y	Y	Y	N	N	N	N	N	Y	Y	Y	Y
PHILIPS-3	Y	Y	Y	Y	N	N	N	N	N	Y	Y	Y	Y
SAE	Y	Y	Y	Y	N	N	N	N	N	Y	Y	Y	Y
Samsung	Y	Y	Y	Y	N	N	N	N	N	Y	Y	Y	Y
Siemens	Y	Y	Y	Y	N	N	N	N	N	Y	Y	Y	Y
SONY-EVI-D30/31	Y	Y	Y	Y	N	N	N	N	N	N	N	N	N
SONY-EVI-D70	Y	Y	Y	Y	N	N	N	N	N	N	N	N	N
SONY-EVI-D100/P	Y	Y	Y	Y	N	N	N	N	N	N	N	N	N
TECHWIN	Y	Y	Y	Y	N	N	N	N	N	N	N	N	N
VICON	Y	Y	Y	Y	N	N	N	N	N	Y	Y	Y	Y

Protocol	PTZ command												
	Tilt up	Tilt down	Pan left	Pan right	Left up	Left down	Right up	Right down	Auto pan	Zoom +	Zoom -	Focus +	Focus -
YOULI	Y	Y	Y	Y	N	N	N	N	N	Y	Y	Y	Y

*: Hikvision only.

Table 24: Supported PTZ commands by camera protocols (Part 2)

Protocol	PTZ command										
	Iris+	Iris-	Light	Wiper	Zoom area	Center	Menu	Preset	Tour	Shadow tour	
Interlogix-485	Y	Y	N	N	N	N	N	Y	N	Y	
Interlogix-422	Y	Y	N	N	N	N	N	Y	N	Y	
KALATEL	Y	Y	N	N	N	N	N	Y	N	Y	
DSCP	Y	Y	N	N	N	N	N	Y	N	Y	
HIKVISION	Y	Y	N	N	Y	Y	Y	Y	Y	Y	
Honeywell	Y	Y	N	N	N	N	N	N	N	N	
INFINOVA	Y	Y	N	N	N	N	N	Y	N	Y	
KTD-348	Y	Y	N	N	N	N	N	Y	N	Y	
LG MULTIX	Y	Y	N	N	N	N	N	Y	Y	Y	
LILIN	Y	Y	N	N	N	N	N	N	N	N	
PANASONIC_CS850	Y	Y	N	N	N	N	N	Y	N	Y	
PELCO-D	Y	Y	Y**	Y#	N	N	N	Y	Y	Y	
PELCO-P	Y	Y	N	N	N	N	N	Y	Y	Y	
PHILIPS	Y	Y	N	N	N	N	N	N	N	N	
PHILIPS-3	Y	Y	N	N	N	N	N	N	N	N	
SAE	Y	Y	N	N	N	N	N	Y	Y	Y	
Samsung	Y	Y	N	N	N	N	N	Y	N	Y	
Siemens	Y	Y	N	N	N	N	N	Y	N	Y	
SONY-EVI-D30/31	N	N	N	N	N	N	N	N	N	N	
SONY-EVI-D70	N	N	N	N	N	N	N	N	N	N	
SONY-EVI-D100/P	N	N	N	N	N	N	N	N	N	N	
TECHWIN	Y	Y	N	N	N	N	N	Y	N	N	
VICON	Y	Y	N	N	N	N	N	N	N	N	
YOULI	Y	Y	N	N	N	N	N	Y	N	N	

** : Aux. 2

: Aux. 1

Appendix F

Default menu settings

Display mode setting	
Monitor	
	General
	Language: English
	Device name: Embedded Net DVR
	Device address: 255
	Zone ID: 1
	VGA resolution: 1280*1024/60HZ
	HDMI resolution : 1920*1080/60HZ(1080P)
	Password required : Yes
	Scale output video: Yes
	Enable wizard: Yes
	More setting
	Monitor standard: NTSC/PAL. Auto detect at booting.
	Output mode: Standard
	Monitor brightness: 5
	Event hint: Yes
	Time bar transparent: Yes
	Menu timeout: 5 min
	Mouse pointer speed: Lower
Layout	
	General
	Video output interface: VGA
	Live view mode: 3*3 (for 4-ch models) or 4*4 (8/16 ch models)
	Dwell time: No switch
	Enable audio output: No
	Event output: HDMI

		Full screen monitoring dwell time: 10 s
	View	
		Video output interface: VGA
		16-chan: 4*4 -A1 to A16
		8-chan: 3*3 - A1 to A8+1black screen
		4-chan: 2*2 - A1 to A4 (Different with PRD-5.1-138)
	Time	
		Time setting
		Time Zone: GMT -8
		Date Format: MM-DD-YYYY
		System date: Current system date
		System time: Current system time
		Auto DST Adjustment: No
		Enable DST: No
		From: Apr 1st Sun 2:00
		To: Oct last Sun 2:00
		DST bias: 60 min
	Holiday	
		Holiday setting
		Status: All disable; Start date: 1st. Jan; End date: 1st Jan
Camera Management		
	OSD	
		OSD setting
		Camera: Analog 1
		Camera name: Camera 01
		Display name: Yes
		Display date: Yes
		Display week: Yes
		Date format: MM-DD-YYYY
		Time format: 12-hour
		Display mode: Not transparent & not flashing
	Image	
		Image setting
		Camera: Analog 1
		Mode: Standard

Motion	
	Motion detection setting
	Camera: All
	Enable motion detection: No
	Rule: Trigger channel [camera-self]; Alarm schedule: All day for whole week; Rule: (Null)
	Sensitivity: Middle
	Target size: 1
	Zone: Full screen
Privacy mask	
	Privacy mask setting
	Camera: All
	Enable privacy mask: No
	Zone: (Null)
Tamper proof	
	Tamper-proof setting
	Camera: All
	Enable tamper proof: No
	Rule: Alarm schedule all day for whole week; Rule: (Null)
	Sensitivity: Low
	Zone: (Null)
Video loss	
	Video loss setting
	Camera: All
	Enable video loss Alarm: Disable
	Rule: Alarm schedule all day for whole week; Rule: (Null)
Video Schedule	
	Schedule
	Record
	Camera: All
	Enable Schedule: Enabled
	Schedule: All day for whole week TL-Hi
Encoding	
	Record
	Camera: All
	Encoding parameters: Main stream (TL-Hi)
	Stream type Video & Audio

	Resolution: 704 x 288 (2CIF)
	Bit rate type: Variable
	Video quality: Higher
	Frame rate: 6 fps
	Max. bit rate mode: General
	Max. bit rate (Kbps): 1722
	Pre-record: 5 s
	Post-record: 5 s
	Auto delete: 0
	Record audio: Yes
Capture	
	Camera: All
	Resolution: 352 x 288 (CIF)
	Picture quality: Medium
V-stream encoding	
	Enable V-stream: No
	Frame rate : 25 fps
	Max. bit rate mode: General
	Max. bit rate (Kbps): 1792
More settings	
More settings	
	Event priority: Text In < Motion
	Overwrite: Yes
Net working setting	
General	
General	
	NIC Type: 10/100/1000M self-adaptive
	Enable DHCP: Enable
	IPv4 address: 192.168.1.82
	IPv4 subnet mask: 255.255.255.0
	IPv4 default gateway: 192.168.1.1
	IPv6 address1: fe80::240:3dff:fe7e:926f/64
	IPv6 address2: (Null)
	IPv6 address gateday: (Null)
	Mac address: (It depends)
	MTU: 1500
	Preferred DNS server: (Null)
	Alternate DNS server: (Null)

PPPoE		
	PPPoE	
		Enable PPPoE: Disable
		User name: (Null)
		Password: (Null)
		Confirm: (Null)
DDNS		
	DDNS	
		DDNS: Disable
		DDNS type: ezDDNS
		Server address: www.tvr-ddns.net
		Host Name: (Null)
		NAT: Disable
		Nat server port: 8000->0
		Nat HTTP port: 80->0
NTP		
	NTP	
		Enable NTP: Disable
		Interval:60min
		NTP server: time.nist.gov
		NTP Port:123
Email	Email	
		(Null)
SNMP	SNMP	
		(Null)
More settings		
	More settings	
		Alarm host IP: (Null)
		Alarm host port: 0
		Server port: 8000
		HTTP port: 80
		Multicast IP: (Null)
		RTSP server port: 554

Alarm setting	
Alarm list	
Alarm Inputs	
	(Null)
Alarm Outputs	
	(Null)
Alarm Input	
Alarm Input	
	Alarm input no.: All
	Alarm name: (Null)
	type: No
	Setting: Disable
	Rule: Trigger No channel, all day for whole week; Rule (Null); PTZ link: (Null)
Alarm Output	
Alarm Output	
	Alarm output no.: All
	Alarm name: (Null)
	Time out: 5 s
	Rule: All day for whole week
Manual Alarm	
	Trigger none
Notification	
Notification	
	HDD full: (Null)
	HDD error: Audio warning
	Network disconnected: (Null)
	IP conflicted: (Null)
	Illegal login: (Null)
	Abnormal video signal: (Null)
	Input/output video standard mismatch: Audio warning
	Abnormal record/capture: Audio warning
PTZ setting	
General	
General	
	Camera: All
	Baud rate: 9600
	Date bit: 8

		Stop bit: 1
		Parity: None
		Flow ctrl: None
		PTZ protocol: Interlogix 485
		Address: 0 to 15 for camera 1 to 16
	More settings	
		(Null)
User setting		
	User	
		User management
		admin:1234
		operate: 4321
		guest: (Null)
		Change password
		(Null)
System setting		
	RS-232	
		RS-232 setting
		Baud rate: 115200
		Date bit: 8
		Stop bit: 1
		Parity: None
		Flow ctrl: None
		Usage: ProBridge
	HDD	
		(NULL)
	Text insertion	
		Text intertion
		Enable text intertion: Disable
		(Null)
	Upgrade	(Null)
	Configuation	(Null)
	Log search	
		Log search
		Current whole day, all day, all type

Glossary

Term	Definition
Data redundancy	Writing data to two or more locations for backup and data recovery. For example, data can be stored on two or more HDDs.
DDNS	Dynamic DNS is a method, protocol, or network service that provides the capability for a networked device, such as a router or computer system using the Internet Protocol Suite, to notify a domain name server to change, in real time (ad-hoc) the active DNS configuration of its configured hostnames, addresses or other information stored in DNS
DHCP	Dynamic Host Configuration Protocol (DHCP) is a network application protocol used by devices (DHCP clients) to obtain configuration information for operation in an Internet Protocol network
Dual stream	Dual stream is a technology used to record high resolution video locally while transmitting a lower resolution stream over the network. The two streams are generated by the DVR, with the main stream having a maximum resolution of 4CIF and the substream having a maximum resolution of CIF.
DVR	Acronym for Digital Video Recorder. A DVR is device that is able to accept video signals from analog cameras, compress the signal and store it on its hard drives
HDD	Acronym for Hard Disk Drive. A storage medium which stores digitally encoded data on platters with magnetic surfaces
HTTP	Acronym for Hypertext Transfer Protocol. A protocol to transfer hypertext request and information between servers and browsers over a network
Hybrid DVR	A hybrid DVR is a combination of a DVR and NVR.
NTP	Acronym for Network Time Protocol. A protocol designed to synchronize the clocks of computers over a network.
NTSC	Acronym for National Television System Committee. NTSC is an analog television standard used in such countries as the United States and Japan. Each frame of an NTSC signal contains 525 scan lines at 60Hz
PAL	Acronym for Phase Alternating Line. PAL is also another video standard used in broadcast televisions systems in large parts of the world. PAL signal contains 625 scan lines at 50Hz.
PTZ	Acronym for Pan, Tilt, Zoom. PTZ dome cameras are motor driven systems that allow the camera to pan left and right, tilt up and down and zoom in and out
USB	Acronym for Universal Serial Bus. USB is a plug-and-play serial bus standard to interface devices to a host computer.

Index

A

- Active X, 109
- Alarm notifications
 - external alarms, 28
 - types, 25
 - video loss, 31
 - video tampering, 32
- Alarm outputs
 - manually acknowledging, 30
- Archiving
 - exporting files to a backup device, 90
 - quick archive, 89
 - snapshots, 92
 - video clips, 91
- Audio
 - connecting audio inputs and outputs, 6

B

- Back panel description, 4
- Backup devices
 - managing, 93
- Brightness, contrast and saturation
 - modifying, 103

C

- Cameras
 - configuring PTZ dome cameras, 69
 - connecting analog cameras using loop-through, 6
 - privacy masking, 102
 - setting up sequencing, 62

D

- Daily schedules
 - recording, 20
- Date
 - configuring display, 63
- DDNS settings, 35
- Default menu settings, 135
- Default settings
 - restore, 96
- Digital zoom
 - description, 60

Digital zoom in playback, 87

- DVR address
 - change, 64
- DVR name
 - change, 64

E

- E-mail notifications
 - set up, 36
- Event logs
 - searching remotely, 115
- Export files, 93
- External alarm
 - setting up to record when triggered, 28
- External alarm schedules
 - recording, 21

F

- Factory default settings
 - restore, 96
- Firmware
 - update, 96
- Frame-by-frame playback, 87
- Front panel description, 46

H

- HDD
 - checking status, 42
 - initializing, 41
 - properties, 42
 - redundancy, 23
 - set to read only, 23
 - setting up HDD alarms, 43
- Holiday schedules
 - recording, 21
- HTTP port settings, 39

I

- Instant playback, 79
- IP devices supported, 120

K

- Keypad

- connecting to RS-485 port, 6
- KTD-4005 keypad
 - connecting the keypad to the DVR, 11
- KTD-405 keypad
 - accessing DVR functions, 126
 - controlling a camera, 129
 - firmware supported, 123
 - set up in zone mode, 124
 - set up TVR 11 device address, 124
 - wiring, 123

L

- Language
 - change GUI language, 64
- Live mode
 - configuring time and date display, 63
- Live view mode
 - digital zoom, 60
 - multiview format, 58
 - sequencing cameras, 58
 - single view format, 57
- Lock/unlock recorded files, 22
- Login password, 64
- Logs
 - view system log, 98

M

- Main menu
 - accessing, 51
 - description, 51
 - icon descriptions, 51
- Menu timeout
 - change time, 64
- Monitors
 - change output mode, 64
 - connecting, 5
 - video outputs, 56
- Motion detection, 25
 - defining motion detection area, 25
 - setting the sensitivity level, 25
 - setting the target size, 25
- Motion search
 - playback, 86
- Mouse pointer speed
 - change, 64
- Mouse pop-up menu, 56
- Multicast settings, 38
- Multiview format, 58

N

- Network packet data
 - exporting, 40
- Network settings
 - general set up, 33
- Network status, 39
- Network traffic
 - checking, 39

- Notifications
 - alarm types, 25
 - external alarms, 28
 - system event types, 30
- NTP server, 36

O

- OSD settings, 101
- Overwriting
 - Protecting recorded files, 22

P

- Password
 - changing user password, 108
 - default user passwords, 105
 - enable/disable login password, 64
- Playback
 - changing playback speed, 87
 - instant playback, 79
 - interface overview, 77
 - motion search, 86
 - playing back archived files, 93
 - search by event, 83
 - search by time, 82
 - search by video type, 82
 - search results, 81
 - snapshots, 84
 - system log, 84
 - using digital zoom, 87
 - using the web browser, 113
- Playback control toolbar
 - description, 78
- Player
 - using for playback, 93
- Power up and down DVR, 13
- PPPoE settings, 34
- Pre-recording times
 - maximum times, 131
- Preset tour
 - calling up, 74
- Preset tours, 73
 - quick access, 70
 - setting up, 73
- Presets
 - calling up, 72
 - quick access, 70
 - selecting, setting up and deleting, 71
 - setting up, 72
- Privacy masking, 102
- Protecting recorded files, 22
- PTZ control panel
 - description, 70
- PTZ dome cameras
 - assigning protocols, 69
 - configuring, 69
 - connecting dome cameras to the DVR, 7
 - connecting to RS-485 port, 6
 - controlling remotely, 115

- set up, 7
- PTZ protocols, 121
 - assigning, 69
 - configuring Interlogix cameras, 7
 - PTZ commands supported, 133

Q

- Quick access toolbar, 59

R

- Recorded files
 - lock/unlock, 22
 - Protect HDD, 23
- Recording
 - configuring settings, 17
 - configuring snapshot settings, 19
 - protecting against overwriting, 22
 - recording schedules, 19
 - setting up HDD redundancy, 23
- Recording schedules
 - daily, 20, 21
 - defining, 19
 - external alarms, 21
- Remote alarm host settings, 38
- Remote control
 - connect to the DVR, 50
 - description, 48
- Resolution
 - change monitor resolution setup, 64
- RS-232 port, 6
 - configuring, 95
- RTSP service port, 39

S

- S.M.A.R.T. information on a HDD, 43
- Sequencing cameras, 58, 62
- Setup wizard
 - using, 14
- Shadow tours
 - quick access, 70
 - setting up, 75
- Single view format, 57
- Snapshots
 - archiving, 92
 - capture remotely, 113
 - playback, 84
 - recording settings, 19
- SNMP protocol settings, 37
- Soft keyboard, 52
- Status icons
 - enable/disable display, 64
- System information
 - view, 97
- System logs
 - major and minor record types, 84
 - playback, 84

- view, 98
- System notifications
 - event types, 30

T

- Tampering
 - detecting video tampering, 32
- Text insertion
 - Via local interface, 24
 - via the browser, 116
- Time
 - configuring display, 63

U

- User privileges
 - camera configuration, 107
 - descriptions, 106
 - local configuration, 106
 - remote configuration, 107
- Users
 - adding a new user, 105
 - customizing user privileges, 106
 - deleting a user, 108
 - managing, 105
 - modifying user information, 108
 - user levels, 105

V

- Video format
 - PAL/NTSC, 13
- Video loss
 - setting up detection, 31
- Video output
 - change manually, 64
- Video outputs, 56
- Video tampering
 - setting up to detect, 32
- View system log, 98
- V-stream encoding, 67

W

- Web browser
 - accessing, 110
 - controlling PTZ dome camera, 115
 - installing Active X, 109
 - local configuration of DVR, 112
 - remote configuration of DVR, 112
 - searching and playing back recorded video, 113
 - searching for event logs, 115
 - text insertion, 116
 - video snapshot, 113
- Wizard
 - enable/disable, 64

