





# IFS MC252-1T-1CXP and MC252-1P-1CX User Manual

<b>Copyright</b>	© 2013 United Technologies Corporation Interlogix is part of UTC Climate Controls & Security, a unit of United Technologies Corporation. All rights reserved.
<b>Trademarks and patents</b>	The IFS MC252-1T-1CXP and MC252-1P-1CX name and logo are trademarks of United Technologies.  Other trade names used in this document may be trademarks or registered trademarks of the manufacturers or vendors of the respective products.
<b>Manufacturer</b>	Interlogix 3211 Progress Drive, Lincolnton, NC 28092 USA Authorized EU manufacturing representative: UTC Climate Controls & Security B.V., Kelvinstraat 7, 6003 DH Weert, Netherlands
<b>Intended use</b>	Use this product only for the purpose it was designed for; refer to the data sheet and user documentation for details. For the latest product information, contact your local supplier or visit us online at <a href="http://www.interlogix.com">www.interlogix.com</a> .
<b>Certification</b>	  N4131
<b>FCC compliance</b>	This equipment has been tested and found to comply with the limits for a Class A digital device, pursuant to part 15 of the FCC Rules. These limits are designed to provide reasonable protection against harmful interference when the equipment is operated in a commercial environment. This equipment generates, uses, and can radiate radio frequency energy and, if not installed and used in accordance with the instruction manual, may cause harmful interference to radio communications.  You are cautioned that any changes or modifications not expressly approved by the party responsible for compliance could void the user's authority to operate the equipment.
<b>ACMA compliance</b>	<b>Notice!</b> This is a Class A product. In a domestic environment this product may cause radio interference in which case the user may be required to take adequate measures.
<b>Canada</b>	This Class A digital apparatus complies with Canadian ICES-003.  Cet appareil numérique de la classe A est conforme à la norme NMB-003du Canada.
<b>European Union directives</b>	<b>2004/108/EC (EMC Directive):</b> Hereby, UTC Climate Controls & Security Corporation, Inc. declares that this device is in compliance with the essential requirements and other relevant provisions of Directive 2004/108/EC.
<b>Contact Information</b>	For contact information, see <a href="http://www.interlogix.com">www.interlogix.com</a> or <a href="http://www.utcssecurityproducts.eu">www.utcssecurityproducts.eu</a> .

# TABLE OF CONTENTS

<b>1. INTRODUCTION</b> .....	<b>1</b>
1.1 PACKAGE CONTENTS .....	1
1.2 PRODUCT FEATURES.....	2
1.3 PRODUCT SPECIFICATIONS.....	3
1.4 PHYSICAL DIMENSIONS.....	5
<b>2. INSTALLATION</b> .....	<b>7</b>
2.1 PRODUCT DESCRIPTION .....	7
2.1.1 Power over Coaxial Extender Front Panel .....	8
2.1.2 LED Indicators .....	8
2.1.3 Power over Coaxial Extender Rear Panel.....	9
2.2 APPLICATIONS OF MC252-1T-1CXP AND MC252-1P-1CX.....	10
<b>3. TROUBLESHOOTING</b> .....	<b>13</b>
<b>APPENDIX A: NETWORKING CONNECTION</b> .....	<b>14</b>
A.1 SWITCH'S RJ-45 PIN ASSIGNMENTS .....	14
A.2 RJ-45 CABLE PIN ASSIGNMENTS.....	14

# 1. INTRODUCTION

Thank you for purchasing IFS Industrial Power over Coaxial Extender, MC252-1T-1CXP and MC252-1P-1CX. The descriptions of the two models are as follows:

MC252-1T-1CXP	PoE over Coaxial Extender - Transmitter (1-Port 10/100TX 802.3at PoE PD + 1-Port BNC PoE )
MC252-1P-1CX	PoE over Coaxial Extender - Receiver (1-Port 10/100TX 802.3at PoE PSE + 12/24V DC Splitter)

“**Industrial Power over Coaxial Extender**” mentioned in this Manual represents the above two models.

## 1.1 Package Contents

Open the box of the Industrial Power over Coaxial Extender and carefully unpack it. The box should contain the following items:

For MC252-1T-1CXP	For MC252-1P-1CX
<ul style="list-style-type: none"><li>● Industrial Power over Coaxial Extender – Transmitter x 1</li><li>● User's Manual x 1</li><li>● Power Adapter and Power Cord</li></ul>	<ul style="list-style-type: none"><li>● Industrial Power over Coaxial Extender –Receiver x 1</li><li>● User's Manual x 1</li></ul>

If any of these are missing or damaged, please contact your dealer immediately; if possible, retain the carton including the original packing material, and use them again to repack the product in case there is a need to return it to us for repair.

## 1.2 Product Features

### Physical Port

■

Model Name	Ports	
	Copper	BNC
MC252-1T-1CXP	1 x 10/100Base-TX (PoE IN)	Power/Data Transmitter
MC252-1P-1CX	1 x 10/100Base-TX (PoE OUT)	Power/Data Receiver

### Power over Ethernet

- Eliminates Power cabling with PoE over Coaxial
- Ethernet over coaxial up to 1km with RG59U/RG6 75 Ohm Low Loss cable
- Complies with IEEE 802.3af / IEEE 802.3at Power over Ethernet on RJ-45 ports
- Supports PoE Power up to 30.8 watts (Vary on Power Source and Coaxial Distance)
- Auto detect powered device (PD) (MC252-1P-1CX)

### Layer 2 Features

- Supports Auto-negotiation and 10/100Mbps half / full duplex and 1000Mbps full duplex mode
- Prevents packet loss with back pressure (Half-Duplex) and IEEE 802.3x PAUSE frame flow control (Full-Duplex)

### VDSL2 Features

- Master / Slave selectable via DIP Switch
- Defines Asymmetric (Band Plan 998) and Symmetric band plans for the transmission of Upstream and Downstream signals

### Industrial Case / Installation



- Supports extensive LED indicators for network diagnostics
- IP30 metal case protection
- Compact size, DIN Rail and Wall Mount Design
- Power Input: External DC or PoE power input
- Supports EFT protection **2000** VDC for power line
- Supports **2000** VDC Ethernet ESD protection
- -40 to 75 degrees C operating temperature

### 1.3 Product Specifications

Model		MC252-1T-1CXP	MC252-1P-1CX
<b>Hardware Specifications</b>			
<b>Interface</b>	<b>Copper</b>	10/100Base-TX RJ-45 Auto-negotiation/ Auto-MDI/MDI-X 802.3at/af PoE Input	10/100Base-TX RJ-45 Auto-negotiation/ Auto-MDI/MDI-X 802.3at/af PoE Output
	<b>Coaxial</b>	BNC, female Power over Coaxial Output	BNC, female Power over Coaxial Input
	<b>DC Socket (Optional)</b>	52~56V DC Input	
	<b>DIP-Switch</b>	2-Position DIP Switch <ul style="list-style-type: none"> <li>■ Selectable <b>CO</b> or <b>CPE</b> mode (Default: <b>CO</b>)</li> <li>■ Selectable Band plan: <b>Asymmetric</b> or <b>Symmetric</b> (Default: Asymmetric)</li> </ul>	2-Position DIP Switch(Front) <ul style="list-style-type: none"> <li>■ Selectable <b>CO</b> or <b>CPE</b> mode (Default: <b>CO</b>)</li> <li>■ Selectable Band plan: <b>Asymmetric</b> or <b>Symmetric</b> (Default: Asymmetric)</li> </ul>
	---	2-Position DIP Switch (Rear) <ul style="list-style-type: none"> <li>■ PoE out or DC out (Default: PoE out)</li> <li>■ 12V DC / 24V DC output voltage (Default: 12V DC)</li> </ul>	
<b>LED Indicators</b>		LED is Green Color <ul style="list-style-type: none"> <li>■ PWR</li> <li>■ PoE IN</li> <li>■ LNK</li> <li>■ CO</li> <li>■ CPE</li> <li>■ LNK/ACT</li> <li>■ 100</li> </ul>	LED is Green Color <ul style="list-style-type: none"> <li>■ PWR</li> <li>■ PoE IN</li> <li>■ PoE Out</li> <li>■ LNK</li> <li>■ CO</li> <li>■ CPE</li> <li>■ LNK/ACT</li> <li>■ 100</li> </ul>
<b>ESD Protection</b>		2KV DC	
<b>EFT Protection</b>		2KV DC	
<b>Enclosure</b>		IP30 metal case	
<b>Installation</b>		Wall mount or DIN rail with optional kit	
<b>Dimensions (W x D x H)</b>		94 x 70.3x 39.2 mm	
<b>Weight</b>		288g	302g
<b>Power Requirements</b>		<ul style="list-style-type: none"> <li>■ RJ-45 PoE Input: 802.3at/af 44~57V DC</li> <li>■ DC Input: 52~56V DC</li> </ul>	<ul style="list-style-type: none"> <li>■ BNC Power over Coaxial Input: 44~57V DC</li> <li>■ DC Input: 52~56V DC</li> </ul>
<b>Performance* (Down / Up Stream)</b>		Asymmetric Mode (Data Only)	
		200m -> 100/65Mbps	800m -> 100/53Mbps
		400m -> 100/64Mbps	1000m -> 94/44Mbps
		600m -> 100/59Mbps	1200m -> 84/36Mbps
<b>Performance* (Down / Up Stream)</b>		Symmetric Mode (Data Only)	
		200m ->100/100Mbps	800m -> 79/80Mbps
		400m -> 97/100Mbps	1000m -> 69/66Mbps
		600m -> 86/91Mbps	1200m -> 60/52Mbps

Power over Ethernet/Coaxial			
<b>PoE Standard</b>		IEEE 802.3at Type 2 IEEE 802.3af	
<b>PSE Interface</b>		BNC 44~57V DC (Depend on what is the DC/PoE Power Input)	RJ-45 48~56V DC, 600mA max. End-Span, Pin 1/2(+), 3/6(-)
<b>PD Interface</b>		RJ-45, both Mid-Span and End-Span Input Range: 44~57V DC	BNC Input Range: 44~57V DC
<b>DC Power Output</b>		-	
<b>Max. PoE Budget</b>	<b>Power Input by PoE</b>	BNC : 25 watts	RJ-45 : 20 watts
	<b>Power Input by DC</b>	BNC : 30 watts	RJ-45 : 30 watts
Standards Conformance			
<b>Standards Compliance</b>		IEEE 802.3 10Base-T Ethernet IEEE 802.3u 100Base-TX Fast Ethernet IEEE 802.3af Power over Ethernet (802.3at Type 1) IEEE 802.3at Power over Ethernet Plus (802.3at Type 2)	
<b>Regulation Compliance</b>		FCC Part 15 Class A, CE	
Environment			
<b>Temperature</b>		Operating: -40~75 degrees C Storage: -40~75 degrees C	
<b>Humidity</b>		Operating: 5~95% (Non-condensing) Storage: 5~95% (Non-condensing)	
Cable			
<b>Coaxial</b>		RG-6/U cable (Low Loss Cable Recommended) max. 500 m with PoE+ (1,640 ft.) max. 700 m without PoE (2,297 ft.) max. 1200 m without PoE (3,937 ft.)	

\* The actual data rate will vary on the quality of the copper wire and environment factors.

	<p>As the MC252-1T-1CXP is power over coaxial, it only can work with MC252-1P-1CX. If connects with Non-PoE coax-LAN equipment, it might cause the equipment to damage.</p> <div style="text-align: center;">  </div>
---	---

Please take care of the conditions of the resistance value of cables as follows.

Coaxial Cable Type	
RG-59/U	Less than 30Ω/1000 ft.
RG-6/U	Less than 12Ω/1000 ft

There are various resistance values in the category of RG-59/U or RG-6/U cable.

# 1.4 Physical Dimensions

- MC252-1T-1CXP: dimensions (W x D x H): 94 x 70.3 x 39.2 mm

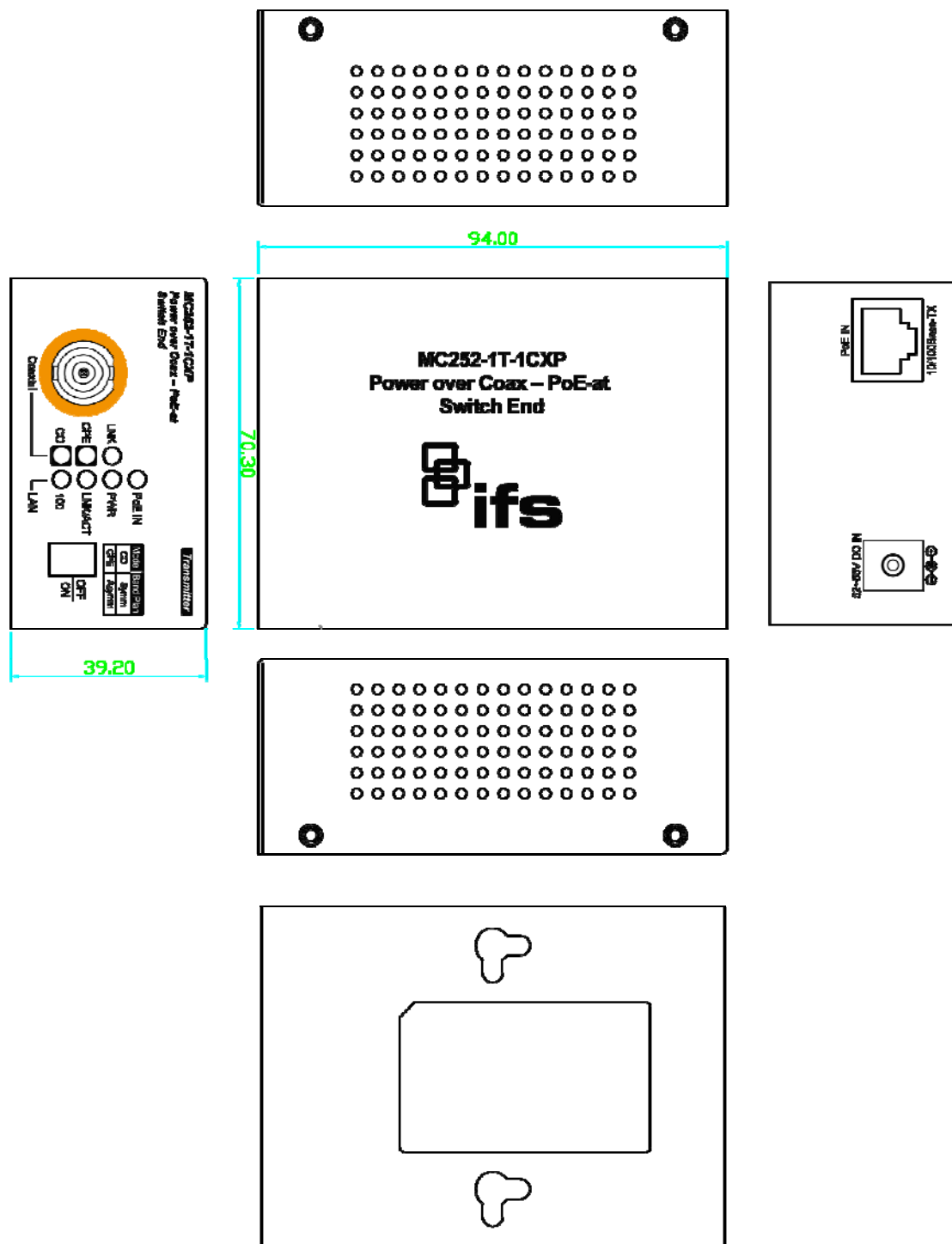



- **MC252-1P-1CX:** dimensions (W x D x H): 94 x 70.3 x 39.2 mm

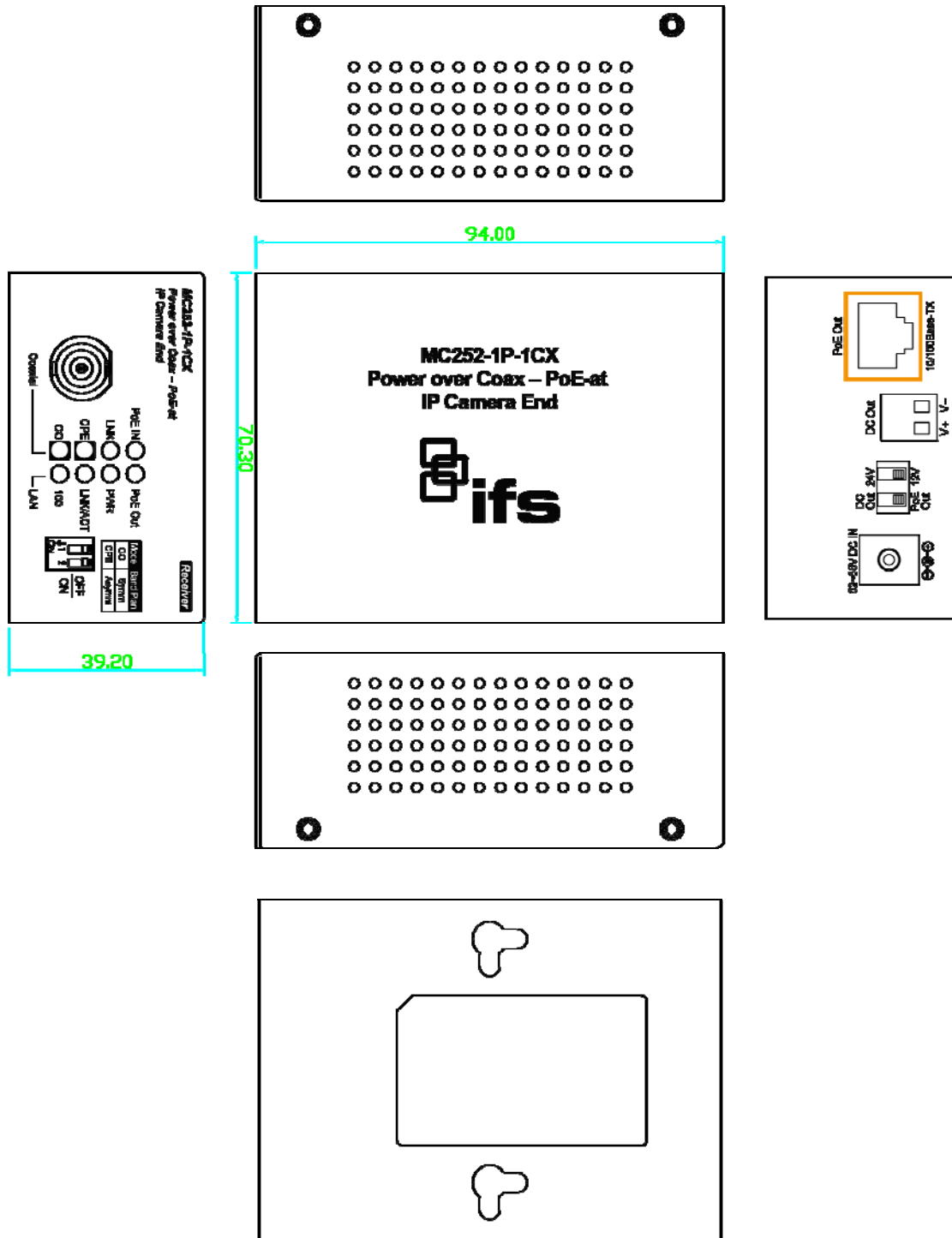

## **2. INSTALLATION**

This section describes the functionalities of the Industrial Power over Coaxial Extender's components and guides you to how to install it on the desktop. Basic knowledge of networking is expected. Please read this chapter completely before continuing.

### **2.1 Product Description**

#### **Power over Coaxial**

Based on IEEE 802.3at high power over Ethernet and up to 30 watts of power output, IFS PoE over coaxial extender solution eliminates the need for additional remote site power while allowing a single PoE source, such as a PoE network switch, to provide power to both transceivers and the camera at long range. This feature eliminates the need for local and remote site power supplies.

#### **IEEE 802.3at/af PoE Injector and Splitter in one box design**

The MC252-1P-1CX is a Single-Port, 802.3at High Power over Ethernet Injector providing maximum up to 30 watts of power output over Ethernet cable which allows data and power to transmit simultaneously through the cable to PoE PD (Powered Device). In addition, the MC252-1P-1CX also features PoE splitter function with selectable 12V/24V DC power output which makes non-PoE equipment power up as well.

#### **Stable Operating Performance under Difficult Environments**

The MC252-1T-1CXP and MC252-1P-1CX extender is the perfect solution for extended distance data and power transmission for warehouses, parking lots, campuses, casinos, and many more. They can operate stably under temperature range from -40 to 75 degrees C which enables the users to conveniently apply the device in almost any location of the network.

## 2.1.1 Power over Coaxial Extender Front Panel

Figure 2-1 and Figure 2-2 show the front panels of the MC252-1T-1CXP and MC252-1P-1CX Industrial Power over Coaxial Extenders.

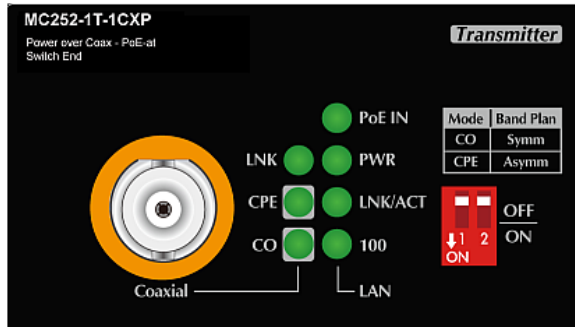

Figure 2-1: MC252-1T-1CXP front panel

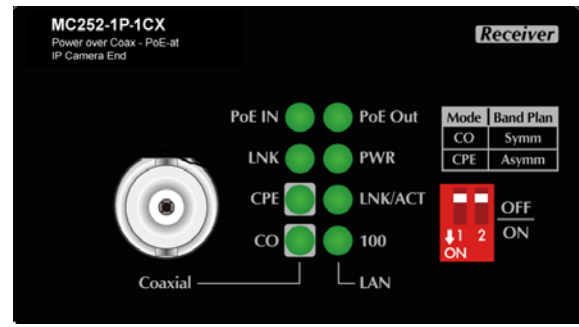

Figure 2-2: MC252-1P-1CX front panel

### ■ Front Panel DIP Switch Setting

The front panels of the MC252-1T-1CXP and MC252-1P-1CX provide one 2-DIP switch which is for configuring coaxial link CO/CPE mode and Band plan function.

Refer to the table below to know about the 2-DIP switch settings and descriptions:

Mode   Band Plan CO   Symm CPE   Asymm	DIP-1   DIP-2	
	Mode	Band Plan
OFF	CO	Symmetric
ON	CPE	Asymmetric

## 2.1.2 LED Indicators

### ➤ System

LED	Color	Function
PWR	Green	Light: indicates the power is on.

### ➤ Coaxial / VDSL2 Interfaces

LED	Color	Function
LNK	Green	Light: indicates that the coaxial link is established.
		Fast Blink: indicates that the coaxial link is at training status (about 10 seconds).
		Slow Blink: indicates that the coaxial link is at idle status.
CO	Green	Light: indicates the coaxial Bridge is running at CO mode.
CPE	Green	Light: indicates the coaxial Bridge is running at CPE mode.

➤ **RJ-45 10/100Base-TX Interfaces**

LED	Color	Function
100	Green	<b>Light:</b> indicates the extender is successfully connecting to the network at 100Mbps.
		<b>OFF:</b> indicates the extender is successfully connecting to the network at 10Mbps.
LNK/ACT	Green	<b>Blink:</b> indicates the extender is actively sending or receiving data over that port.

➤ **RJ-45 PoE Indicators**

LED	Color	Model	Function
PoE IN	Green	VC-203PT	<b>Light:</b> indicates the RJ-45 port is receiving the PoE Power.
		MC252-1P-1CX	<b>Light:</b> indicates the BNC connector is receiving the PoE Power.
PoE Out	Green	MC252-1P-1CX	<b>Light:</b> indicates the RJ-45 Port is providing PoE power

**2.1.3 Power over Coaxial Extender Rear Panel**

Figure 2-3 and Figure 2-4 show the rear panels of the MC252-1T-1CXP and MC252-1P-1CX Industrial Power over Coaxial Extenders.



Figure 2-3: MC252-1T-1CXP rear panel

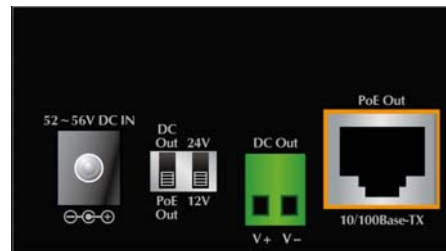

Figure 2-3: MC252-1P-1CX rear panel

■ **MC252-1P-1CX Rear Panel: DIP Switch Setting**

		DIP-1	DIP-2
		Power Output	Voltage
OFF	DC Out	24V	
ON	PoE Out (default)	12V (default)	

**MC252-1P-1CX Rear Panel: 2-Pin Terminal Block**

If there is no power socket in the network environment for Non-PoE networked device, the MC252-1P-1CX can be of great help by conveniently and easily providing this Ethernet device with DC power. Via the DIP switch configuration, the MC252-1P-1CX separates the power out and provides two kinds of DC power output and its voltage and current are shown below:

- 12V DC, 2A max.
- 24V DC, 1A max.

	<ul style="list-style-type: none"> <li>MC252-1P-1CX has two power output options; only one mode is available at one time. It cannot use DC power output if power output of DIP switch is in PoE output position.</li> <li>Disconnect “PoE IN” coaxial cable before changing 12/24V DIP Switch. Incorrect voltage from “DC Out” might cause damage to connected device.</li> </ul>
---	---

## 2.2 Applications of MC252-1T-1CXP and MC252-1P-1CX

Type 1 – MC252-1T-1CXP with 52~56V power adapter and MC252-1P-1CX with PoE power output

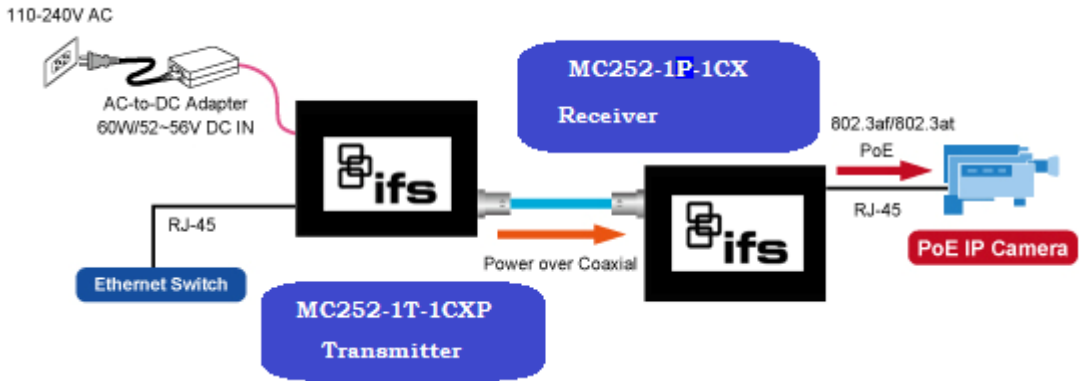

	CPE	CO
	MC252-1T-1CXP	MC252-1P-1CX
Power Input	Power adapter with 52~56V DC in	BNC with DC power over coaxial input
Power Output	BNC with DC power over coaxial output	RJ-45 with 802.3at/af PoE output

	<ol style="list-style-type: none"> <li>PoE Output Capacity is based on different DC Power Input / PoE Input.</li> <li>MC252-1T-1CXP has two power input options; only one mode is available at one time. It cannot use PoE power input if power input of DC 52V or 56V is selected.</li> </ol>
---	--

**Type 2 – MC252-1T-1CXP with 52~56V power adapter and MC252-1P-1CX with DC power output**

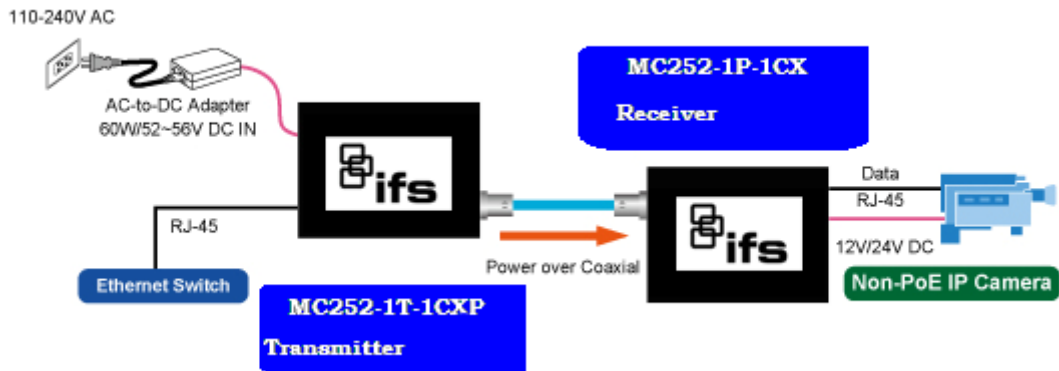

	CPE	CO
	MC252-1T-1CXP	MC252-1P-1CX
Power Input	Power adapter with 52~56V DC in	BNC with DC power over coaxial input
Power Output	BNC with DC power over coaxial output	DC Terminal block with 12V or 24V DC output

	<ol style="list-style-type: none"> <li>1. Please ensure the <b>MC252-1P-1CX</b> output voltage is correct for remote device.</li> <li>2. Please plug off the PoE Coaxial cable from <b>MC252-1P-1CX</b> before switching off the Power Voltage DIP during operation. Wait for 3 seconds until the "PoE IN" LED is completely OFF. Otherwise, it might damage your devices.</li> </ol>
--	---

**Type 3 – MC252-1T-1CXP with PoE power input and MC252-1P-1CX with PoE power output**

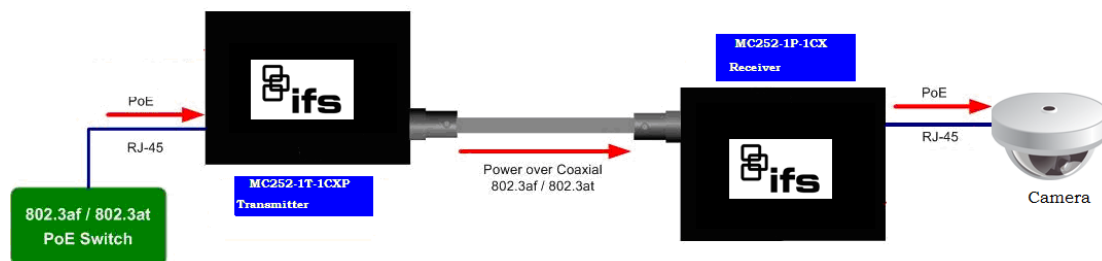

	CPE	CO
	MC252-1T-1CXP	MC252-1P-1CX
Power Input	RJ-45 with 802.3at/af PoE input	BNC with DC power over coaxial input
Power Output	BNC with DC power over coaxial output	RJ-45 with 802.3at/af PoE output



The MC252-1T-1CXP accepts IEEE 802.3at equipment for optimal power injection. Any other Non-standard PoE Power devices may cause the MC252-1T-1CXP to malfunction.

**Type 4 – MC252-1T-1CXP with PoE power input and MC252-1P-1CX with DC power output**

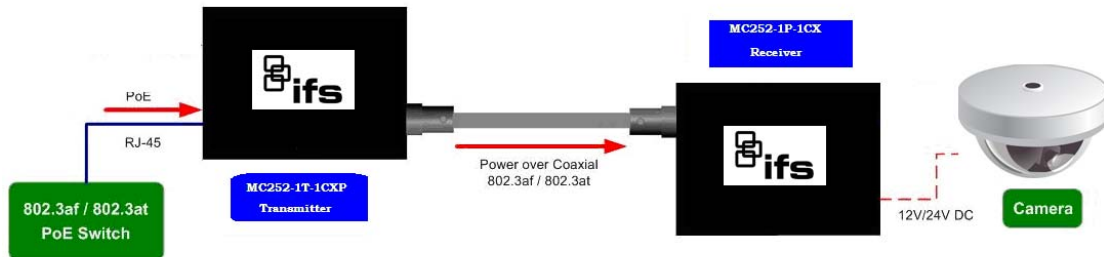

	CPE	CO
	MC252-1T-1CXP	MC252-1P-1CX
Power Input	RJ-45 with 802.3at/af PoE input	BNC with DC power over coaxial input
Power Output	BNC with DC power over coaxial output	DC Terminal block with 12V or 24V DC output



As the MC252-1T-1CXP is power over coaxial, please confirm that other Non-PoE equipment is not connected with the coaxial cable. When you connect the coaxial cable with coax-LAN converter, CCTV camera, etc, it might cause other equipment to damage.



### 3. TROUBLESHOOTING

This chapter contains information to help you solve issues. If the Industrial Power over Coaxial Extender is not functioning properly, make sure the Industrial Power over Coaxial Extender was set up according to instructions in this manual.

#### **VDSL LNK LED does not light after wire is connected to the VDSL port.**

##### **CHECKPOINT:**

1. Verify the length of the wire connected between MC252-1T-1CXP and MC252-1P-1CX. It should not be more than 2.4km.
2. Please note you must use one for CO mode and the other with CPE mode, and connect to each other to make it work.

#### **TP LED does not light after cable is connected to the port.**

##### **CHECKPOINT:**

1. Verify you are using the Cat.5, 5e or 6 cables with RJ-45 connector to connect to the port.
2. If your device (like LAN card) supports Auto-Negotiation, please try to manually modify at a fixed speed of your device.
3. Check whether the power of the converter and the connected device is ON or OFF.
4. Check the port's cable is firmly seated in its connectors in the switch and in the associated device.
5. Check the connecting cable is good.
6. Check the power adapters are functional, including the connecting device.

#### **Available Bandwidth is less than expected**

##### **CHECKPOINT:**

The actual data rate will vary on the quality of the **coaxial cable** and environment factors.

#### **My POE PD Device doesn't get power when connected to MC252-1P-1CX?**

##### **CHECKPOINT:**

1. Please check and assure the device is fully complied with IEEE 802.3af / IEEE 802.3at standard
2. Please check the cable type of the connection from MC252-1P-1CX to the other end. The cable should be an 8-wire UTP, Category 5 or above, and EIA568 cable within 100 meters. A cable with only 4-wire, short loop or over 100 meters will affect the power supply.



# APPENDIX A: NETWORKING CONNECTION

## A.1 Switch's RJ-45 Pin Assignments

10/100Mbps, 10/100Base-TX

RJ-45 Connector pin assignment		
Contact	MDI Media Dependant Interface	MDI-X Media Dependant Interface -Cross
1	Tx + (transmit)	Rx + (receive)
2	Tx - (transmit)	Rx - (receive)
3	Rx + (receive)	Tx + (transmit)
4, 5	Not used	
6	Rx - (receive)	Tx - (transmit)
7, 8	Not used	

## A.2 RJ-45 Cable Pin Assignments

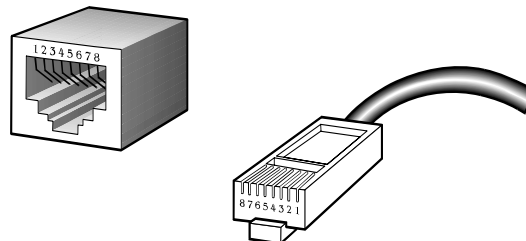

**The standard RJ-45 receptacle/connector**

There are 8 wires on a standard UTP/STP cable and each wire is color-coded. The following shows the pin allocation and color of straight cable and crossover cable connection:

Straight Cable								Crossover Cable	
1	2	3	4	5	6	7	8	SIDE 1	SIDE 2
1	2	3	4	5	6	7	8	1 = White / Orange	1 = White / Orange
								2 = Orange	2 = Orange
								3 = White / Green	3 = White / Green
								4 = Blue	4 = Blue
								5 = White / Blue	5 = White / Blue
								6 = Green	6 = Green
								7 = White / Brown	7 = White / Brown
								8 = Brown	8 = Brown

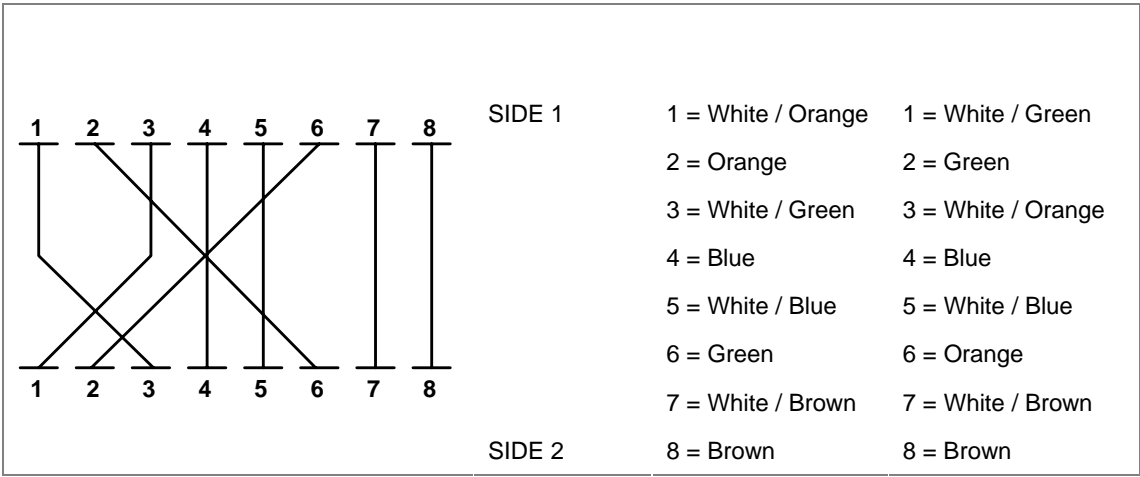

**Figure A-1: Straight-Through and Crossover Cable**

Please make sure your connected cables are with the same pin assignment and color as the above picture before deploying the cables into your network.

