

# TruVision High Definition TVI Bullet Camera Installation Guide

TVB-2402/TVB-4402

TVB-2404/TVB-4404

TVB-2405/TVB-4405



# Contents

Product overview	2
Camera description	4
Installation	7
Built-in heater in the TVB-2405/4405 camera	11
Program	11
Menu trees	17
Specifications	19
Legal and regulatory information	21

# Product overview

This is the TruVision High Definition TVI Bullet Camera Installation Guide for models TVB-2402/TVB-4402, TVB-2404/TVB-4404 and TVB-2405/TVB-4405. This guide describes a standard installation.

## Package contents

- Camera with power and video output cables
- 4 screws and 4 anchors for wall or ceiling installation

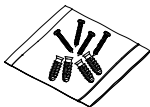
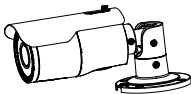

- Back box
- Screws M4.8 × 18, 4 pcs to attach the back box



- **Template**



- **Installation guide**

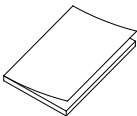

- **CD**



- **Hex wrench**



- **WEEE disposal sheet**

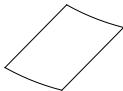

- **BNC monitor output cable**

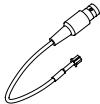

## Camera description

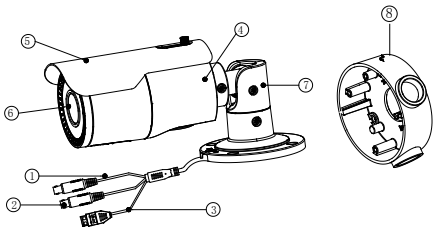

- |                        |                     |
|------------------------|---------------------|
| 1. CVBS output (black) | 5. Sun shield       |
| 2. TVI output (grey)   | 6. Lens             |
| 3. Power cable         | 7. Mounting bracket |
| 4. Camera body         | 8. Back box         |

### Note:

Please check the camera output settings before setting up a system. The TVI video output can be only connected to a DVR with a TVI signal input. The CVBS output supports a standard CVBS monitor (or test monitor), an encoder or a DVR.

For 720P VF bullet cameras, TVB-2402 / TVB-4402, the CVBS and TVI output can not be used at the same time. Use the built-in switch to select the camera video output.

For 1080P VF bullet cameras, such as TVB-2404/TVB-4404 and TVB-2405/TVB-4405, the built-in switch is used to enable/disable the WDR feature. When the WDR feature is enabled, the CVBS output will be blocked.

**Figure 1: TVB-2402 /TVB-4402**

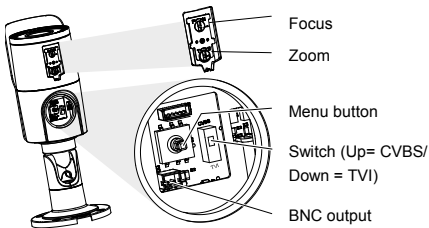

**Figure 2: TVB-2404 /TVB-4404**

---

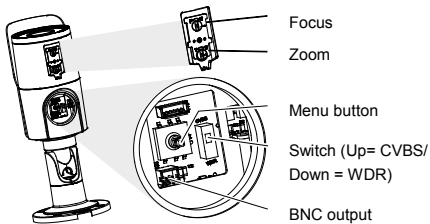

**Figure 3: TVB-2405 /TVB-4405**

---

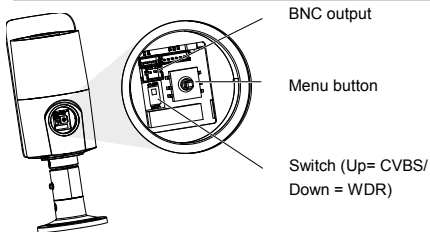



# Installation

## To install the camera:

1. Using the template, place it level against the mounting surface and mark the position of the mounting holes.

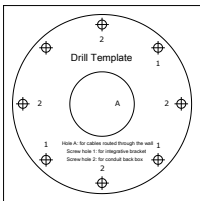

2. Following all local safety regulations, drill and prepare the mounting holes.
3. As an optional step, install the back box on the wall.

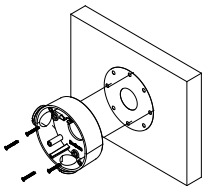

4. Route the cables to the cable hole and connect the corresponding cables. Using a 75-ohm coaxial video cable, connect the camera TVI video output to a TVI DVR, and connect a 12 VDC or 24 VAC power supply to the power cable.
5. Secure the camera to the ceiling or wall with the screws provided.

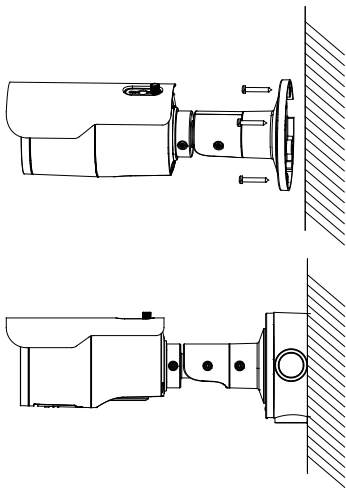

6. Loosen the three screws on the mounting bracket and adjust the camera angle according to the figure below to the optimum position. Tighten the screws after completing the adjustment.

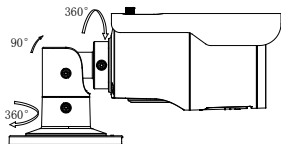

## 7. Zoom and focus adjustment

- a) Manually adjust the zoom and focus on TVB-2402/TVB-4402 and TVB-2404/TVB-4404.

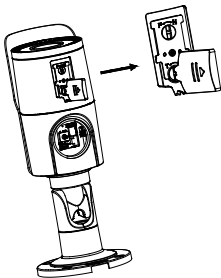

- b) TVB-2405/TVB-4405 has a motorized lens. Please adjust its zoom and focus by using

the zoom and focus buttons on the PTZ panel of a connected recorder or controller.

## Built-in heater in the TVB-2405/4405 camera

The TVB-2405/4405 camera has a built-in heater that works within the temperature range of -40 and +60 °C (-40 to +140 °F). The heater only works at 24 VAC.

When the camera initially starts up, the heater will start to work automatically when the temperature is below -10 °C (14 °F). However, with continuous operation the heater will not work until the internal temperature drops below -30°C (-22 °F).

**Note:** The TVB-2402/4402 and TVB-2404/4404 operating temperature range is between -30 and +60 °C (-22 to +140 °F).

## Program

Once the camera hardware has been installed, you can then program the camera.

The camera has a built-in OSD button and supports UtC (Up-to-Coax) control over both CVBS and TVI outputs.

## Using the buttons

Please press the **Menu** button to call up the OSD menu and select an OSD item.

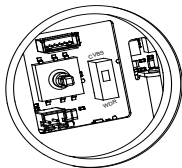

Press the button up/down to move the cursor up or down to an OSD item.

Press the button left/right to move the cursor left or right to adjust the value of a selected OSD item.

## Using a TVI output

Programming over the camera's TVI output can be done via a TVI DVR.

Connect the TVI cable to the DVR, as shown below.

**Figure 4: TVI cable connection**

---

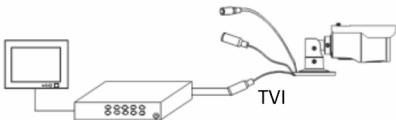

Access the PTZ menu of the connected DVR, set the **TruVision-Coax** protocol and use the PTZ control panel to configure the camera.

Click **Iris+** to access to the camera OSD menu and select an OSD item.

Click the directional buttons UP or DOWN to move the cursor up or down to an OSD item.

Click the directional buttons LEFT or RIGHT to move cursor left or right to adjust the value of a selected OSD item.

**Note:** TVB-2405/TVB-4405 has a motorized lens. Please use the ZOOM and FOCUS buttons to adjust its zoom and focus.

For more details, refer to the TVI DVR user manual.

## Using a CVBS output

A TVS-C200 (purchase separately) can be used to program the camera over its CVBS output, not the TVI video output.

Connect a monitor and the TVS-C200 controller (if required) as shown below.

**Figure 5: CBSC cable connections**

---

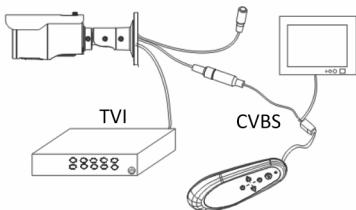

Press the **OK** button of the TVS-C200 for a few seconds until you see the OSD menu display on the monitor. You can also use the **OK** button to select an OSD item.



Use the directional buttons to move cursor and adjust value.

For more details, refer to the TVS-C200 user manual.

### **TVB-2402/TVB-4402 camera**

The camera has CVBS and TVI dual video outputs. Set the built-in switch to **CVBS** to view the program on a standard monitor.

The TVI is blocked until the camera configuration is complete and the switch is reset to **TVI**.

See Figure 5 on page 17 to see the menu tree.

### **TVB-2404/TVB-4404 and TVB-2405/TVB-4405 cameras**

The cameras have CVBS and TVI dual video outputs. The built-in switch is for WDR/CVBS selection. Set the built-in switch to **CVBS** to view the setup menu on a standard monitor.

When the programming is finished, you can change the switch setting to **WDR** to enable the WDR feature. In such case, the CVBS output will be disabled.

If the switch is set to **CVBS**, the WDR feature is disabled and the camera has both CVBS and TVI output available.

See Figure 6 on page 18 to see the menu tree.

# Menu trees

Figure 6: TVB-2402/TVB-4402 menu tree

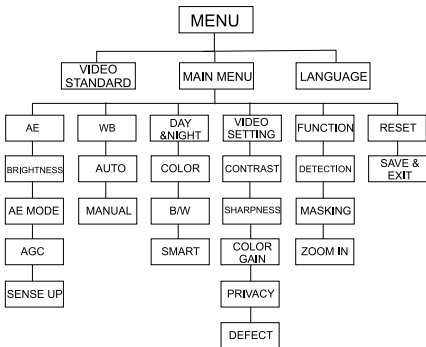

**Figure 7: TVB-2404/TVB-4404 and TVB-2405/TVB-4405 menu tree**

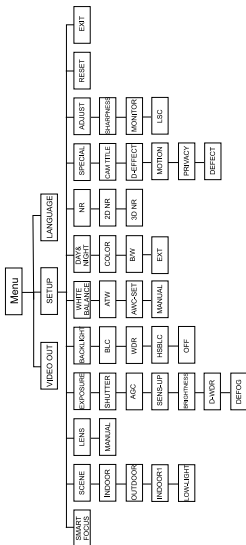

# Specifications

---

Power supply	12 VDC / 24 VAC
Current	<b>TVB-2402 / TVB-4402:</b>
	12 VDC: Max. 333 mA
	24 VAC: Max. 250 mA
	<b>TVB-2404/TVB-4404:</b>
	12 VDC: Max. 420 mA
	24 VAC: Max. 250 mA
<b>TVB-2405/TVB-4405:</b>	
12 VDC: Max. 1A	
24 VAC: Max. 500 mA	
Power consumption	<b>TVB-2402/TVB-4402:</b>
	12 VDC: Max. 4W
	24 VAC: Max. 6W
	<b>TVB-2404/TVB-4404:</b>
	12 VDC: Max. 5W
	24 VAC: Max. 6W
<b>TVB-2405/TVB-4405:</b>	
12 VDC: Max. 12W	
24 VAC: Max. 12W	

---

Weight (net)	<b>TVB-2402/TVB-4402:</b>
	860 g / 1.89 lb. (without back box)
	1075 g / 2.36 lb. (with back box)
	<b>TVB-2404/TVB-4404:</b>
	860 g / 1.89 lb. (without back box)
	1075 g / 2.36 lb. (with back box)
Dimensions	<b>TVB-2405/TVB-4405:</b>
	880 g / 1.94 lb. (without back box)
	1095 g / 2.41 lb. (with back box)
	<hr/>
	105 × 94.7 × 265.4 mm / 4.13 × 3.74 × 10.4 in. (without back box )
	105 × 94.7 × 301.4 mm / 4.13 × 3.74 × 11.86 in. (with back box)
	<hr/>

# Legal and regulatory information

## Copyright:

© 2016 United Technologies Corporation. All rights reserved.  
Interlogix is part of UTC Climate, Controls & Security, a unit of United Technologies Corporation.

## Trademarks and patents:

Trade names used in this document may be trademarks or registered trademarks of the manufacturers or vendors of the respective products.

## Manufacturer:

Interlogix

2955 Red Hill Avenue, Costa Mesa, CA 92626-5923, USA

Authorized EU manufacturing representative:

UTC Fire & Security B.V.

Kelvinstraat 7, 6003 DH Weert, The Netherlands

## Certification:



## FCC compliance: Class A

Class A: This equipment has been tested and found to comply with the limits for a Class A digital device, pursuant to part 15 of the FCC Rules. These limits are designed to provide reasonable protection against harmful interference when the equipment is operated in a commercial environment. This equipment generates, uses, and can radiate radio frequency energy and, if not installed and used in accordance with the instruction manual, may cause

harmful interference to radio communications. Operation of this equipment in a residential area is likely to cause harmful interference in which case the user will be required to correct the interference at his own expense.

### **ACMA compliance**

Notice! This is a Class A product. In a domestic environment this product may cause radio interference in which case the user may be required to take adequate measures.

### **Canada**

This Class A digital apparatus complies with Canadian ICES-003. Cet appareil numérique de la classe A est conforme à la norme NMB-0330 du Canada.

### **European Union directives:**

**12004/108/CE (EMC directive):** Hereby, UTC Fire & Security declares that this device is in compliance with the essential requirements and other relevant provisions of Directive 2004/108/EC.



**2012/19/EU (WEEE directive):** Products marked with this symbol cannot be disposed of as unsorted municipal waste in the European Union. For proper recycling, return this product to your local supplier upon the purchase of equivalent new equipment, or dispose of it at designated collection points. For more information see: [www.recyclethis.info](http://www.recyclethis.info).

### **Contact information:**

For contact information, see [www.interlogix.com](http://www.interlogix.com) or [www.utcssecurityproducts.eu](http://www.utcssecurityproducts.eu)









