

DR-RWM-AD Installation Instructions

Description

Dimensions: $\varnothing 129 \times 3 \text{ mm}$ ($\varnothing 5.08 \times 0.12 \text{ in.}$)

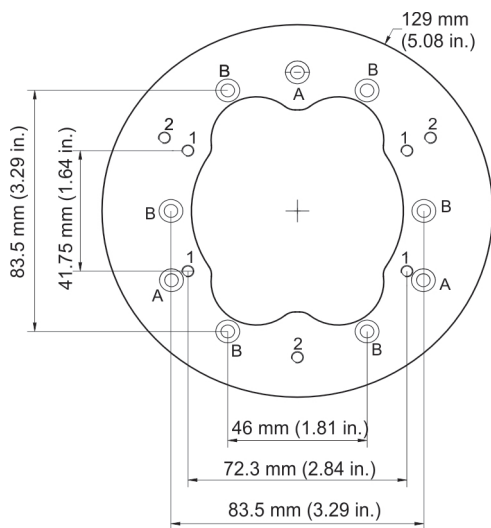

Weight: 127.6 g (0.28 lb.)

Accessories:

Screw A 4 pcs
(Used for attaching the adapter to DR-RWM or TVD-M2-WM bracket)

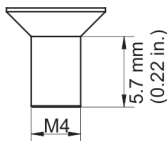

Screw B 4 pcs
(Used for attaching camera to the adaptor plate)

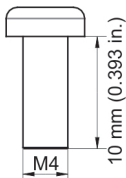

Description of holes:

Hole A	DR-RWM: DR series wall mount bracket
Hole B	TVD-M2-WM: TruVision series wall mount bracket

Hole 1 **TruVision IP wedge cameras with adapter**
NTSC: TVD-N210W-4-N, TVD-M1210W-2-N, TVD-M1210W-2W-N, TVD-M2210W-4-N, TVW-3101, TVW-3102, TVW-3107, TVW-3108, TVW-3109
PAL: TVD-N210W-4-P, TVD-M1210W-2-P, TVD-M1210W-2W-P, TVD-M2210W-4-P, TVW-1101, TVW-1102, TVW-1107, TVW-1108, TVW-1109

TruVision wireless IP wedge cameras with adapter

NTSC: TVW-3103, TVW-3104, TVW-3105, TVW-3106

PAL: TVW-1103, TVW-1104, TVW-1105, TVW-1106

TruVision analog wedge cameras with adapter

NTSC: TVW-4101

PAL: TVW-2101

Hole 2 **TruVision IP plastic dome**

NTSC: TVD-3105, TVD-3106.

PAL: TVD-1105, TVD-1106,

TruVision IP indoor plastic dome

NTSC: TVD-3101, TVD-3102.

PAL: TVD-1101, TVD-1102,

TruVision HD-TVI plastic dome

NTSC: TVD-4401, TVD-4403.

PAL: TVD-2401, TVD-2403

Installation

To attach DR-RWM-AD to DR-RWM wall-mount bracket:

1. Attach the DR-RWM-AD to the DR-RWM bracket by inserting three A screws into holes A (see the *Dimensions figure* for the location of the holes).

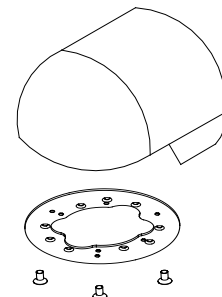

2. Attach a camera to the DR-RWM-AD by inserting the B screws into holes 1 or 2.

To attach DR-RWM-AD to TVD-M2-WM wall-mount bracket:

1. Attach the DR-RWM-AD to the TVD-M2-WM bracket by inserting three A screws into holes B (see the *Dimensions figure* for the location of the holes).

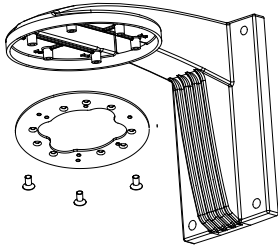

2. Attach a camera to the DR-RWM-AD by inserting screws B into holes 1 or 2.

To attach a plastic dome to DR-RWM-AD:

1. Remove the housing, complete the cabling work and then attach the dome to the bracket by inserting three B screws into holes 2 (see the *Dimensions* figure for the location of the holes).

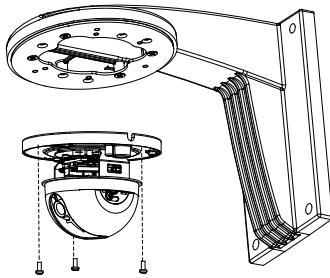

2. Adjust the lens for the correct surveillance angle and then attach the housing to the camera.

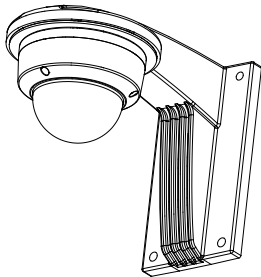

To attach a wedge camera to DR-RWM-AD:

1. Attach the wedge adaptor (supplied in the wedge camera package) to the DR-RWM-AD by inserting four B screws into holes 1 (see the *Dimensions* figure for the location of the holes).

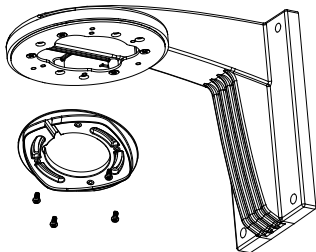

2. Remove the housing of the wedge camera, complete the cabling work and then attach the camera to the adaptor.

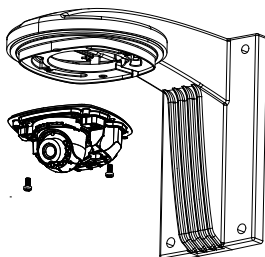

3. Adjust lens for the correct surveillance angle and then attach the housing to the camera.

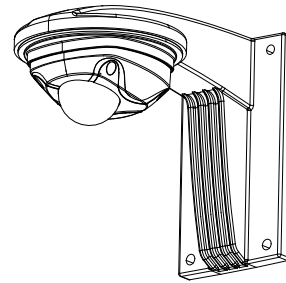

Legal information

Trademarks and patents

The trade names used in this document may be trademarks or registered trademarks of the manufacturers or vendors of the respective products.

Contact information

For contact information, see www.interlogix.com or www.utcssecurityproducts.eu.