

HPSB series power supply unit



Buffer, switch mode power supply unit 13,8V DC

EN**

CODE: **HPSB 7012E** v.1.0/VII
TYPE: **HPSB 13,8V/6A/65Ah Buffer, switch power supply unit**

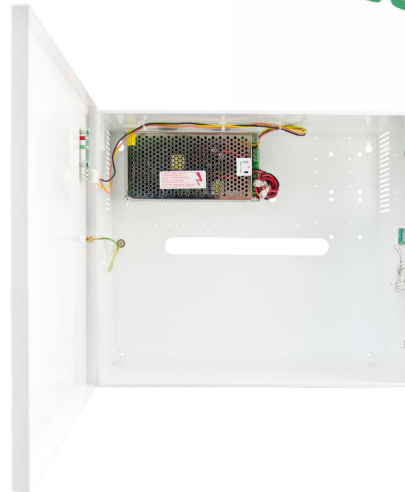

GREEN POWER

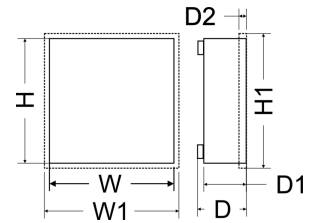

Features:

- DC 13,8V/6A uninterruptible power supply*
- fitting battery: 65Ah/12V
- wide range of mains supply: 176÷264V
- high efficiency 80%
- battery charging and maintenance control
- excessive discharging (UVP) protection
- jumper selectable battery charge current 1A/2A
- battery output full protection against short-circuit and reverse polarity connection
- LED indication
- protections:
 - SCP short-circuit protection
 - OVP overvoltage protection
 - overvoltage protection (AC input)
 - against sabotage
 - overload protection (OLP)
- warranty – 2 year from the production date

DESCRIPTION

A buffer PSU is intended for an uninterrupted supply to devices requiring stabilised voltage of **12V DC (+/-15%)**. The PSU provides voltage of **U=13,8V DC**. Current efficiency:

1. Output current 6A + 1A battery charge*
2. Output current 5A + 2A battery charge*

Total device current + battery: 7A max*.

In case of power decay, a battery back-up is activated immediately. The PSU is constructed based on the switch mode PSU, with high energy efficiency. The PSU is housed in a metal enclosure (colour RAL 9003) which can accommodate a 65Ah/12V battery. A micro switch indicates door opening (front cover).

* Refer to chart 1

HPSB series power supply unit



Buffer, switch mode power supply unit 13,8V DC

SPECIFICATIONS	
PSU type	A (EPS - External Power Source)
Mains supply	176÷264V AC 50÷60Hz
Current up to	0,95A@230VAC
Supply power	100W max.
Efficiency	80%
Output voltage	13,8V DC – buffer operation 9,5V÷13,8V DC – battery-assisted operation
Output current $t_{AMB}<30^{\circ}\text{C}$	6A + 1A battery charge - refer to chart 1 5A + 2A battery charge - refer to chart 1
Output current $t_{AMB}=40^{\circ}\text{C}$	4,9A + 1A battery charge - refer to chart 1 3,9A + 2A battery charge - refer to chart 1
Voltage adjustment range	12÷14VDC
Ripple	120mV p-p max.
Battery charge current	1A / 2A max. @ 65Ah ($\pm 5\%$) – jumper selectable
Short-circuit protection SCP	electronic, automatic return
Overload protection OLP	105-150% of the PSU power, automatic return
Battery circuit protection SCP and reverse polarity connection	PTC polymer fuse
Surge protection	varistors
Overvoltage protection OVP	>16V (automatic recovery)
Excessive discharge protection UVP	U<9,5 V ($\pm 5\%$) – disconnect of connection battery
Sabotage protection: - TAMPER output indicating enclosure opening	- microswitch, NC contacts (enclosure closed), 0,5A@50V DC (max.)
LED indication	Yes
Operating conditions	2nd environmental class, $-10^{\circ}\text{C}\div 40^{\circ}\text{C}$
Enclosure	Steel plate DC01, thickness: 1,0mm, colour: RAL 9003
Enclosure dimensions	400 x 350 x 170+8 [mm] (WxHxD)
Net/gross weigh	6,0 / 6,4 kg
Fitting battery	65Ah/12V (SLA) max. 360 x 175 x 165mm (WxHxD) max
Closing	Cheese head screw x 2 (at the front), lock assembly possible
Declarations, warranty	CE, RoHS, 2 year from the production date
Notes	The enclosure does not adjoin the assembly surface so that cables can be led. Convectional cooling. Connectors: Power-supply: $\Phi 0,63\div 2,5$ Battery output BAT: 6,3F-2,5.

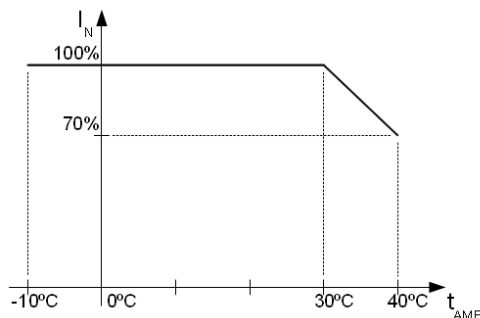

CHART 1. Acceptable output current from the PSU depending on ambient temperature.

HPSB series power supply unit



Buffer, switch mode power supply unit 13,8V DC

Optional configurations:

Buffer power supply unit HPSB 13,8V/4x1,5A/65Ah.

- HPSB7012E + LB4 4x1,5A (AWZ576) + 65Ah

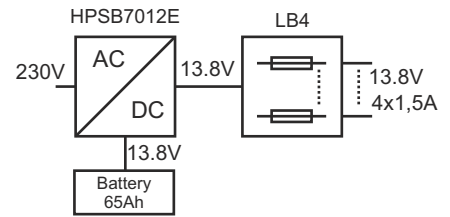

Buffer power supply unit HPSB 13,8V/6x1A/65Ah.

- HPSB7012E + LB8 6x1A (AWZ579 or AWZ580) + 65Ah

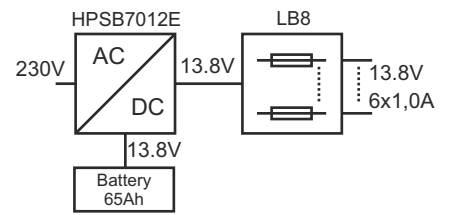

Buffer power supply unit HPSB 13,8V/12x0,5A/65Ah.

- HPSB7012E + 2xLB8 12x0,5A (AWZ578 or AWZ580) + 65Ah
 - HPSB7012E + LB8 8x0,5A (AWZ578 or AWZ580)+LB4 4x0,5A (AWZ574 or AWZ576) + 65Ah

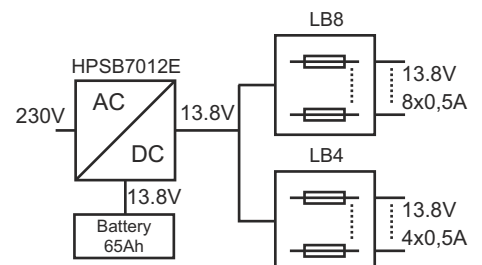
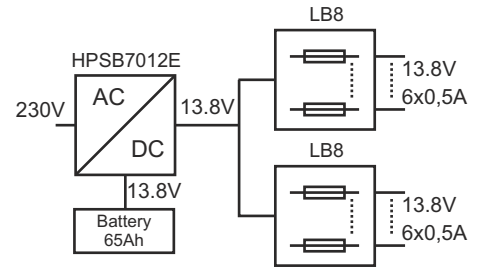
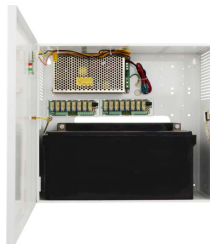

Buffer power supply unit HPSB 13,8V/2x12V/2x3A/65Ah.

- HPSB7012E + 2xRN500 (13,8V/12V) + 65Ah

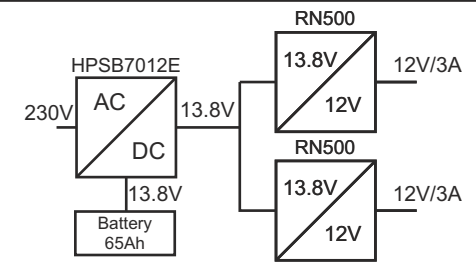

Buffer power supply unit HPSB 13,8V/2x12V/6x1A/65Ah.

- HPSB7012E + 2xRN500 (13,8V/12V)+2xLB4 6x1A (AWZ575 or AWZ576) + 65Ah

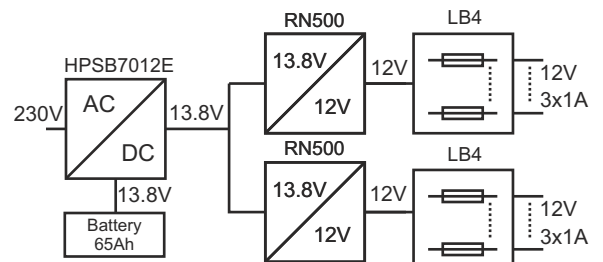

HPSB series power supply unit



Buffer, switch mode power supply unit 13,8V DC

Optional configurations:

Buffer power supply unit HPSB 13,8V/2x12V/12x0,5A/65Ah.

- HPSB7012E + 2xRN500 (13,8V/12V)+2xLB8
12x0,5A (AWZ578 or AWZ580) + 65Ah

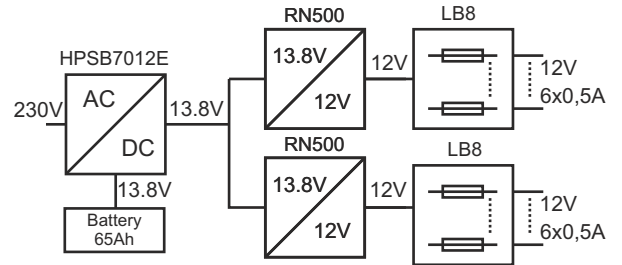

Buffer power supply unit HPSB 13,8V/3x5V÷7,4V/3x2A/65Ah.

- HPSB7012E + 3xDCDC20 (3x5V÷7,4V/3x2A) + 65Ah

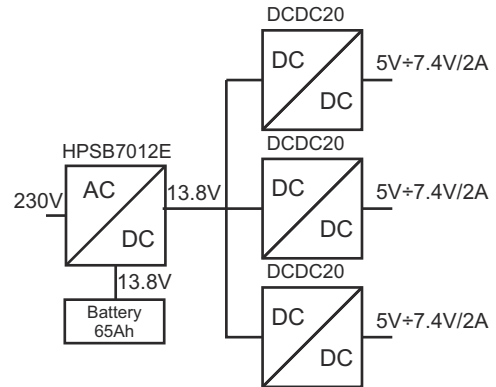

Buffer power supply unit HPSB 13,8V/3x5V÷7,4V/6x1A/65Ah.

- HPSB7012E + 3xDCDC20 (3x5V÷7,4V/3x2A)+
3xLB2 6x1A (AWZ585 or AWZ586) + 65Ah

